

Informational Pamphlet for Election Day Voting



Prepared and Distributed by:
Secretary of State

Approved by:
Attorney General, Pursuant to La. R.S. 18:421

Disposition: Return Pamphlet in the [Green Canvas Bag](#)

Table of Contents

Table of Contents

Commissioner Open Polls Checklist

Part 1: Emergencies	1
1.01: Emergency Procedures	1
1.02: Before the Election	1
1.03: During the Election	1
1.04: After the Election	1
Part 2: Contact Information	2
2.01: Secretary of State	2
2.02: Parish Contacts	2
Part 3: Opening the Polling Place	4
3.01: Voting Hours	4
3.02: Deputy Custodian Responsibilities	4
Figure 1: Key Envelope A	4
Figure 2: Supplemental List Envelope (L-SL)	5
3.03: Commissioner-in-Charge/Commissioner Responsibilities	5
3.04: Examine the Polling Place Facility	6
Figure 3: A-Frame "VOTE HERE" Disability Sign	6
3.05: Watchers/Alternate Watchers	7
3.06: Super Watchers	7
3.07: Helpful Information for Voters with Disabilities	8
Part 4: Verifying Voting Machines and Election Supplies	9
4.01: Verify Voting Machines	9
Figure 4: Voting Machine Serial Number	9
4.02: Verify Election Supplies	10
Figure 5: General Forms Zipper Bag	10
Figure 6: Precinct Specific Envelope (PSE)	11
Figure 7: Notation of Irregularities Form	12
4.03: Helpful Aids for the Voters	13
Part 5: Posting Election Information	14
5.01: What to Post at the Polling Place	14
Part 6: Inspecting and Operating Voting Machines	15
6.01: Inspection of the Voting Machines	15

Figure 8: Blue Results/Audio Cartridge.....	15
6.02: Inspection of the Precinct Register Seals.....	16
6.03: Setting up the Voting Machines	16
Figure 9: Positioning Voting Machine	16
Figure 10: Daisy Chain Set-up.....	17
6.04: Turning the Voting Machine Power “ON”	17
Figure 11: Operator Panel within Back of Unit	17
Figure 12: Operator Panel in Position	18
Figure 13: Power On-Off Button	18
6.05: Opening the Polls	19
Figure 14: Operator Panel - “Ready to Open Polls”	19
Figure 15: Opening Polls Diagram.....	19
Figure 16: Operator Panel Diagram.....	20
Figure 17: Official Election Zero Proof Report.....	21
6.06: Rotating the Voter Panel to the Voting Position	22
Figure 18: Positioning the Voter Panel to the Vertical Position (Part 1).....	22
Figure 19: Positioning the Voter Panel to the Vertical Position (Part 2).....	22
Figure 20: Pull Maroon Latch on Tub and Tilt to the Upright Voting Position	23
6.07: Front Doors and Curtain	23
Figure 21: Open Side Door Panels	23
Figure 22: Connect the Top Panel with Side Panels	24
Figure 23: Privacy Curtain - Location.....	24
Figure 24: Privacy Curtain - Installation	25
Figure 25: Privacy Curtain - Installed	25
6.08: Audio Unit.....	26
Figure 26: Audio Unit.....	26
Figure 27: Connect Audio Unit to the Back of the Voting Machine	26
6.09: Closing the Back of Machine	27
Figure 28: Closing Back Panel Door and Cord Groove Location	27
6.10: Voting Machine Keys	27
Figure 29: B-02 Key Envelope (Front)	27
Figure 30: B-02 Key Envelope (Back).....	28
6.11: Voting Machine Certificate (MC-52) No. 1.....	29
Figure 31: Machine Certificate No. 1	30
Part 7: Election Day Procedures.....	31
7.01: Preparing to use the Precinct Register.....	31

Figure 32: Supplemental Precinct Register Page	31
Figure 33: Precinct Register Correction Affidavit Page	31
Figure 34: Precinct Register Provisional Voter Page	32
Figure 35: Precinct Register Assistance to Voters Page	32
7.02: Supplemental List Envelope (L-SL).....	32
7.03: Identification of Voters	33
Figure 36: Voter Identification Affidavit (AV-34)	35
7.04: Election Day Etiquette	35
7.05: Precinct Register and Poll List	37
7.06: Address Confirmation Card - Election Day (ACC) Form.....	38
Figure 37: Address Confirmation Card-Election Day (ACC) Form.....	39
7.07: Signature of the Applicant in Precinct Register	40
7.08: Error in Precinct Register or Voter's Record	40
7.09: Omissions in Precinct Register	40
Figure 38: Precinct Register Correction (PRC) Form	41
7.10: Assistance to Voters	42
7.11: Louisiana Laws Regarding Assistance	42
7.12: Disability Documentation	42
Figure 39: Voter Assistance Form (VAF)	43
Figure 40: Precinct Register Diagram	44
7.13: Prohibited People for Assisting Voters	45
7.14: Documenting Voter Assistance	45
Figure 41: Assistance to Voters Page.....	45
7.15: How to Assist a Voter with a Disability	46
Figure 42: Maroon Latch on Voting Machine	46
7.16: Audio Voting	47
7.17: Allowing Voters to Vote.....	47
Figure 43: Poll List.....	47
7.18: Precincts without a Lockout	48
Figure 44: Operator Panel	49
7.19: Precincts with a Lockout	50
7.20: Audio Voter.....	52
7.21: Challenge of Voter at Polls	53
Figure 45: Challenge of Voter (CV-56) Form	53
7.22: Disposition of the Challenge	53
Part 8: Closing the Polling Place	55

8.01: When to Close the Polling Place.....	55
8.02: Extended Poll Hours Voting (Federal Elections)	55
8.03: Procedures after Polling Place Has Been Closed	55
Figure 46: Closing Polls.....	56
Figure 47: Storing the Voting Curtain.....	56
Figure 48: Closing Front Doors of Voting Machine	57
Figure 49: Turn Power Switch to Off.....	58
Figure 50: Results/Audio Cartridge Port Location and Removal (Part 1).....	58
Figure 51: Results/Audio Cartridge Port Location and Removal (Part 2).....	59
Figure 52: Official Election Results Report	60
Figure 53: Machine Certificate (MC-52) No. 2.....	61
Figure 54: Affidavit of Payroll and Non-Disclosure (AFF-PND)	62
8.04: Completing Required Post-Election Paperwork	63
Figure 55: ROV (Registrar of Voters Envelope).....	64
Figure 56: S-19 Secretary of State Envelope.....	64
Figure 57: Green Canvas Bag	65
Figure 58: C-03 Key Envelope.....	66
Figure 59: Clerk’s Clear Plastic Zipper Bag	67
Part 9: Federal Elections	68
9.01: What are Federal Elections?.....	68
9.02: Federal Election Supplies	68
9.03: Closing the Polling Place during Federal Elections	68
Figure 60: Braille Booklet Envelope (BBE)	69
Figure 61: Election Day Provisional Packet	69
Part 10: Provisional Voting (Federal Elections Only)	70
10.01: What is Provisional Voting?	70
10.02: When is Provisional Voting Available?	70
10.03: Who is a Provisional Voter?.....	70
10.04: Procedure for Determining Provisional Ballot Voter	71
Figure 62: Provisional Ballot Affidavit Envelope (AFF-PB).....	71
10.05: Election Day Provisional Voting Procedures	72
10.06: Precinct Voting - Provisional Voting Chart	73
Part 11: Criminal Acts.....	76
11.01: State Law Prohibitions	76
11.02: Federal Law Prohibitions	77
Part 12: Law Enforcement	78

12.01: Law Enforcement Officers.....	78
12.02: Elections Compliance Unit.....	78
Part 13: Commissioners.....	79
13.01: Qualifications, Powers and Duties	79
13.02: Powers & Duties, Commissioner-in-Charge	80
13.03: Powers & Duties, Commissioners.....	80
13.04: Payment	80
13.05: Disqualification, Commissioner-in-Charge	81
13.06: Disqualification, Commissioner	81
Commissioner Close Polls Checklist	

Commissioner Open Polls Checklist

- Take the commissioner oath and acknowledgement located on the back of this pamphlet.
- Verify that you have the correct voting machines by comparing the information on the **Key Envelope A** (Figure 1 Pg. 4) to the voting machine serial numbers on the permanent label located on the voting machine. If the precinct number or machine numbers do **not** match, **immediately** call the clerk of court or voting machine warehouse technician.
- Complete a polling place accessibility check to ensure that the voting machines, tables, and any other voter areas can accommodate voters with disabilities and are free of any obstructions or tripping hazards.
- Position the voting machines and lock the wheels of the voting machines in place using the brakes (Figure 9 Pg. 16).
- Plug in the first voting machine, daisy-chain the others together (Figure 10 Pg. 17), and check for the **yellow AC power light** on each voting machine.
- Always open every voting machine.** Use the **yellow-capped key** to unlock the back door of the voting machines. Complete the voting machine security check; compare the seal numbers on the **Key Envelope A** with the red protective seal number on the cover over the **Blue Results/Audio Cartridge** (Figure 8 Pg. 15) and the red seal on the precinct register. If any numbers do not match or seals are broken, call the clerk of court or the voting machine warehouse technician **immediately**.
- Verify you have received the correct election day supplies by checking against the enclosed packing lists; if not, call the clerk of court **immediately**.
- Attach the operator panel(s) onto the voting machine(s) (Figure 11 & 12 Pgs. 17 & 18).
- Turn the voting machine power switch to the “ON” position (Figure 13 Pg. 18). Powering “On” & “Off” does not require a key.
- After the voting machines have powered up, the operator panel display should read “**READY TO OPEN POLLS ELECTION.**” Record the voting machine serial numbers, cartridge seal numbers, the public and protective counter numbers, any visible damage to a voting machine, and precinct register seal(s) on Certificate No. 1 of the **Machine Certificates (MC-52)** (Figure 31 Pg. 30).
- Use the **silver key** to open the polls. The operator panel display reads “**VOTER INACTIVE POLLS OPEN**” (Figure 16 Pg. 20) and one (1) **Official Election Zero Proof Report** (Figure 17 Pg. 21) will begin printing. Place the **silver key** in the **B-02 Key Envelope** (Figures 29 & 30 Pgs. 27 & 28) and **do NOT use the silver key again until time to close the polls.**
- If the operator panel shows an “ERROR” upon powering on, call the clerk of court or the voting machine technician for instructions.
- Raise the face of the voting machine into a vertical position without forcing it into position. (At least 2 commissioners are recommended to complete this step and the next one.)
- Tilt back the face of the voting machine into the upright voting position by pulling the **maroon latch release**.
- Unlock the front panels with the **yellow-capped key**, unfold the booth, and attach the curtain assembly.
- Remove the audio unit bag and connect it to the back of the voting machine (required by law).
- Remove the **Official Election Zero Proof Report** from the printer, verify it, have each commissioner sign it, and post on the wall of the polling place.
- Put the voting machine cord through the cord groove location, close the back door, and lock it with the **yellow-capped key**.
- Record key numbers on the **B-02 Key Envelope** and have the commissioner-in-charge and all commissioners sign the envelope.
- Place all keys in the **B-02 Key Envelope** and seal the envelope.
- Post all signs and the sample ballot and wait for the voters.

Note: For voting machine problems, immediately call the clerk of court or the voting machine technician and make a written report of the issue on the **Notation of Irregularities Form**. (Figure 7 Pg.12)

Part 1: Emergencies

1.01: Emergency Procedures

- A. Any time an emergency of any type threatens the conduct of a scheduled election, the Secretary of State's Office will contact local officials for information and suggestions concerning actions that are necessary.
- B. The Secretary of State's Office will also consult with other agencies, such as the Office of Emergency Preparedness, the Governor's Office, the National Guard, and weather experts, if necessary.
- C. Local officials should always contact the Secretary of State's Office prior to taking any type of action concerning an emergency that may affect an election, if time permits.

1.02: Before the Election

- A. If there is an emergency (such as a hurricane) threatening to occur just before or on the day of a scheduled election, notification of any actions taken will be directed by the secretary of state to the local clerks of court and registrars of voters.
- B. Precinct commissioners should contact the local clerk of court for information.
- C. Final decisions concerning emergency actions are made by the secretary of state, in conjunction with the governor.

1.03: During the Election

- A. If there is an emergency on election day that requires any action on the part of the precinct commissioners, the Clerk of Court's Office or the voting machine warehouse technicians will contact the precincts with instructions.
- B. If there is an emergency on election day and the polling place must be evacuated for any reason, it is very important that the voting machines are powered "OFF" only and the polls are **NOT CLOSED**. Once powered off, remove the **Blue Results/Audio Cartridge(s)** containing the votes on the voting machines and deliver to the clerk of court or voting machine warehouse, or, if necessary, the commissioner-in-charge keeps possession to deliver to the clerk of court at the earliest opportunity.
- C. Do not leave the **Blue Results/Audio Cartridge** in the voting machines in a polling place with votes still recorded on them, if possible.

1.04: After the Election

- A. If there is an emergency (such as a hurricane) that affects the day and time that the voting machines are picked up and returned to the warehouse, the Clerk of Court's Office will be notified.

Part 2: Contact Information

2.01: Secretary of State

A. The Louisiana Secretary of State's phone numbers are listed on the back cover.

2.02: Parish Contacts

Parish	Clerk of Court	Registrar of Voters	Voting Machine Warehouses
Acadia	(337) 788-8881	(337) 788-8841	(337) 788-7527
Allen	(337) 639-4351	(337) 639-4966	(337) 639-4347
Ascension Gonzales* Donaldsonville**	(225) 621-8400* (225) 473-9866**	(225) 621-5780* (225) 473-7906**	(225) 644-5045
Assumption	(985) 369-6653	(985) 369-7347	(985) 369-7135
Avoyelles	(318) 253-7523	(318) 253-7129 (318) 253-0367	(318) 253-7979
Beauregard	(337) 463-8595	(337) 463-7955	(337) 463-9749
Bienville	(318) 263-2123	(318) 263-7407	(318) 263-2224
Bossier	(318) 965-2336	(318) 965-2301	(318) 741-7333
Caddo	(318) 226-6788	(318) 226-6891	(318) 868-9793
Calcasieu	(337) 437-3550	(337) 721-4000	(337) 625-9516 (337) 882-1733
Caldwell	(318) 649-2272	(318) 649-7364	(318) 649-2244
Cameron	(337) 775-5316	(337) 775-5493	(337) 775-2237
Catahoula	(318) 744-5497	(318) 744-5745	(318) 339-8461
Claiborne	(318) 927-9601	(318) 927-3332	(318) 927-2584
Concordia	(318) 336-4204	(318) 336-7770	(318) 757-4359
DeSoto	(318) 872-3110	(318) 872-1149	(318) 872-3008
E. Baton Rouge	(225) 295-4765	(225) 389-3940	(225) 925-6529 (225) 925-4117 (225) 922-2323
E. Carroll	(318) 559-2399	(318) 559-2015	(318) 559-3745
E. Feliciana	(225) 683-5145	(225) 683-3105	(225) 683-5430
Evangeline	(337) 363-5671	(337) 363-5538	(337) 363-4112
Franklin	(318) 435-5133	(318) 435-4489	(318) 435-2142
Grant	(318) 627-3246	(318) 627-9938	(318) 627-5426
Iberia	(337) 365-7282	(337) 369-4407	(337) 373-0044
Iberville	(225) 687-5160	(225) 687-5201	(225) 687-4460
Jackson	(318) 259-2424	(318) 259-2486	(318) 259-7625
Jefferson East* West**	(504) 736-6394	(504) 736-6191* (504) 349-5690**	(504) 465-3486* (504) 471-2731* (504) 349-8893** (504) 349-8895**
Jeff. Davis	(337) 824-1160	(337) 824-0834	(337) 824-1769
Lafayette	(337) 291-6400	(337) 291-7140	(337) 262-5770
Lafourche	(985) 447-4841	(985) 447-3256	(985) 447-0969
LaSalle	(318) 992-2158	(318) 992-2254	(318) 992-6946

Parish	Clerk of Court	Registrar of Voters	Voting Machine Warehouses
Lincoln	(318) 251-5130	(318) 251-5110	(318) 251-4154
Livingston	(225) 686-4007 (225) 686-4027	(225) 686-3054	(225) 686-7929
Madison	(318) 574-0655	(318) 574-2193	(318) 574-2015
Morehouse	(318) 281-3343	(318) 281-1434	(318) 283-0840
Natchitoches	(318) 352-8152	(318) 357-2211	(318) 357-3194
Orleans	(504) 658-9000	(504) 658-8300	(504) 242-0441 (504) 242-0652 (504) 242-0727 (504) 242-2597
Ouachita	(318) 327-1444	(318) 327-1436	(318) 397-3459
Plaquemines	(504) 934-6610	(504) 934-3620	Call ROV
Pointe Coupee	(225) 638-9596	(225) 638-5537	(225) 638-7891
Rapides	(318) 473-8153	(318) 473-6770	(318) 487-5716
Red River	(318) 932-6741	(318) 932-5027	(318) 932-6915
Richland	(318) 728-7000	(318) 728-3582	(318) 728-2134
Sabine	(318) 256-6223	(318) 256-3697	(318) 256-4111
St. Bernard	(504) 271-3434	(504) 278-4232 (504) 278-4231 (504) 278-4230	(504) 278-6670
St. Charles	(985) 783-6632	(985) 783-5120	(985) 783-1753
St. Helena	(225) 222-4521	(225) 222-4440	(225) 222-6196
St. James	(225) 562-2270 (225) 562-2272	(225) 562-2445 (225) 562-2330	(225) 869-8422
St. John	(985)-497-3331 Ext. 2104	(985)-652-9797	(985) 536-1389
St. Landry	(337) 942-5606 Ext. 102	(337) 948-0572	(337) 948-0245 (337) 948-0360
St. Martin	(337) 394-2210	(337) 394-2204	(337) 332-1203
St. Mary	(337) 828-4100 Ext. 216	(337) 828-4100 Ext. 360	(337) 828-5928
St. Tammany	(985) 809-8700	(985) 809-5500	(985) 893-6237
Tangipahoa	(985) 748-4146	(985) 748-3215	(985) 543-4147
Tensas	(318) 766-3921	(318) 766-3931	(318) 766-3275
Terrebonne	(985) 868-5660	(985) 873-6533	(985) 857-3674
Union	(318) 368-3055	(318) 368-8660	(318) 368-8640
Vermilion	(337) 898-1992	(337) 898-4324	(337) 893-3520
Vernon	(337) 238-1384	(337) 239-3690	(337) 238-6402
Washington	(985) 839-7821	(985) 839-7850	(985) 839-3878
Webster	(318) 371-0366	(318) 377-9272 (318) 426-9821	(318) 371-3041
W. Baton Rouge	(225) 383-0378	(225) 336-2421	(225) 342-8243
W. Carroll	(318) 428-3281	(318) 428-2381	(318) 428-4302
W. Feliciana	(225) 635-3794	(225) 635-6161	(225) 635-6991
Winn	(318) 628-3515	(318) 628-6133	(318) 628-3155

Figure 2: Supplemental List Envelope (L-SL)

PARISH	WARD(S)	PRECINCT(S)
---------------	----------------	--------------------

Supplemental List Envelope

L-SL

ATTENTION COMMISSIONER-IN-CHARGE OPEN IMMEDIATELY!

This envelope contains a List of Voters Who Voted Absentee by Mail AND/OR a Supplemental Precinct Register.

LIST OF VOTERS WHO VOTED ABSENTEE BY MAIL
(NAMES OF VOTERS THAT VOTED ABSENTEE BY MAIL, BUT ARE NOT LISTED AS SUCH ON THE PRECINCT REGISTER)
Instructions: Find the voter's name in the Precinct Register and write "voted absentee" in the signature column of the Precinct Register, then place your initials as you would for any other voter. If the voter has already signed the Precinct Register, **PLEASE CONTACT THE REGISTRAR OF VOTERS OFFICE IMMEDIATELY.** Once you have completed marking all the voters on this list, please place the list back in this envelope and put it in the back of the Precinct Register.

SUPPLEMENTAL PRECINCT REGISTER
(NAMES OF VOTERS WHO ARE ELIGIBLE TO VOTE, BUT ARE NOT ON THE PRECINCT REGISTER)
Instructions: Place this list behind the tab in the Precinct Register marked "supplemental" and refer to it as part of the Precinct Register.

ROV INSTRUCTIONS: Place supplemental lists in this envelope and mark appropriately.

Prepared and Furnished by the Secretary of State Supplemental List Envelope (L-SL) (Rev. 7/21)

3.03: Commissioner-in-Charge/Commissioner Responsibilities

- A. Be at the polling place by 6:30 a.m. for Saturday elections or 5:30 a.m. for Tuesday elections. If the building is not open, call the Clerk of Court's Office.
- B. If the commissioner-in-charge has not arrived by 6:30 a.m. on Saturday elections or 5:30 a.m. on Tuesday elections, call the Clerk of Court's Office and a replacement commissioner-in-charge will be sent to the polling place immediately. A replacement commissioner-in-charge in a primary election also serves in the general election.
- C. If any commissioner has not arrived by 6:30 a.m. on Saturday elections or 5:30 a.m. on Tuesday elections (or if a commissioner is selected to serve as the commissioner-in-charge), the commissioner-in-charge will select an alternate commissioner. A replacement commissioner in a primary election also serves in the general election. The clerk of court must approve any commissioner replacement made after 8 a.m. on election day.
- D. If there are not enough alternate commissioners available, the commissioner-in-charge selects a replacement commissioner from the following categories in the order listed:
 - 1. A person on the list of those who received certificates of instruction furnished by the parish board of election supervisors;
 - 2. Any person present at the polls who has the qualifications of a commissioner; or
 - 3. A commissioned poll watcher.
- E. The commissioner-in-charge **MUST** administer the oath, located on the back of this pamphlet, to the commissioners prior to 7 a.m. on Saturday elections or 6 a.m. on Tuesday elections. If there is a replacement commissioner-in-charge, the commissioners shall do the same to the person selected as the replacement.

3.04: Examine the Polling Place Facility

- A. Safety hazards and barriers to voters with disabilities, such as loose electrical cords, hallway clutter, unsecured mats or rugs, and/or locked doors, **MUST** be secured or removed.
- B. All political materials within a distance of 600 feet of the entrance to the polling place **MUST** be removed, **except political materials located on private property**.
- C. If there is any temporary equipment (portable ramps, accessible parking place signs and cones, etc.) for the polling place, it must be in place before 7 a.m. on Saturday elections or 6 a.m. on Tuesday elections. If an exterior or interior door is not accessible, the door must be propped open before 7 a.m. on Saturday elections or 6 a.m. on Tuesday elections and remain open until 8 p.m. The clerk of court will advise you in these matters.
- D. The polling place is provided with an A-Frame “VOTE HERE” Disability Sign(s) (*Figure 3*); the commissioner **MUST** place the sign(s) outside the polling place closest to the entrance of the polling place where voters can see the sign(s) from the road.

Figure 3: A-Frame “VOTE HERE” Disability Sign



3.05: Watchers/Alternate Watchers

- A. Each candidate is entitled to have one commissioned watcher at every precinct on election day where their name is on the ballot. An alternate watcher may also be commissioned for every precinct. A watcher may be commissioned for more than one (1) precinct.
- B. Any person who is supporting or opposing a proposition (including the recall of a public official), who has filed a report required by La. R.S. 18:1486 (Campaign Finance) is entitled to have one commissioned watcher at every precinct in which the proposition is on the ballot. This determination will be made by the parish board of election supervisors.
- C. Verify that watchers or alternate watchers have commissions for your precinct issued by the parish board of election supervisors. After verification, return the commission to the watcher.
- D. A watcher and alternate watcher for the same candidate or proposition may not serve at the same time, but may alternate time throughout the day.
- E. If the number of watchers inside a polling place interferes with the orderly conduct of the election, the commissioners have the authority to limit the number of watchers by allowing the watchers to draw lots to determine which watchers shall be first to wait outside (*La. R.S. 18:427*). If possible, try to make sure the amount of time each watcher spends inside is equal.
- F. **Rights and responsibilities of a watcher:** A watcher or alternate watcher may keep notes on the conduct of the election and shall
 1. present their commission to the commissioner-in-charge of the precinct to which they are assigned;
 2. be admitted to all parts of the polling place during the election and the counting of votes;
 3. not take part in the counting and tabulation of votes, but may observe;
 4. be subject to the authority of the commissioners;
 5. not interfere with the commissioners in the performance of their duties;
 6. notify the commissioners of any infraction of the law; and
 7. not electioneer, engage in political discussions, or unnecessarily delay a voter at the polling place.

3.06: Super Watchers

- A. In addition to watchers and alternate watchers per precinct, each candidate may designate one (1) watcher as a super watcher who can be admitted in every precinct in the candidate's election at the same time as either the watcher or alternate watcher who is serving for the candidate. A super watcher has the same authority as a watcher.
- B. Verify that the super watcher has a commission issued by the parish board of election supervisors. After verification, return the commission to the super watcher.

3.07: Helpful Information for Voters with Disabilities

- A. Before the polls open in the morning on election day, check the area for objects that might be a mobility hazard, such as electrical cords, clutter in hallways, unsecured mats or rugs, locked doors, or any other barrier that could limit access to a voter with a disability.
- B. Make sure the polling place has clearly marked disability signage. Entrances should be marked, ramps should be in place, and there should be at least one wheelchair van accessible parking space for every 25 spaces.
- C. If you see there are physical barriers at your polling site that you cannot correct, **immediately** contact the Secretary of State's Office at 1-800-883-2805.
- D. Treat a voter with a disability with the same attention and respect as all voters.
- E. Use the appropriate language, such as "person with a disability" or "voter with a disability." Do not use terms such as "crippled," "handicapped," or "special needs."
- F. If a voter with a disability arrives at the polling place with someone to provide assistance, be sure to speak to the voter during the voting process; do not ignore the voter by only speaking to the helper.
- G. Before attempting to help a voter with a disability, be sure to ask first. Wait for your offer of help to be accepted, and then listen carefully to the voter with a disability as they explain the type of help needed.

IMPORTANT: Any voter who has a visible physical disability or who presents a current mobility-impaired identification card bearing the photograph of the voter and the international symbol of accessibility issued by the Department of Public Safety and Corrections, along with the person assisting them in voting, **MUST BE ALLOWED TO GO TO THE FRONT OF THE LINE** to cast a ballot.

Part 4: Verifying Voting Machines and Election Supplies

4.01: Verify Voting Machines

- A. When the voting machine keys have been received from the deputy custodian, check the machine serial number on the permanent label of each voting machine and compare the information to the voting machine serial numbers on the **Key Envelope A**, making sure all numbers match and you have the correct machines for your precinct.
- B. The voting machine serial number is on a permanent label (*Figure 4*) located in two (2) places on the voting machine, either on the top or the side of the AVC Advantage voting machine.
- C. If the precinct number or machine serial numbers do **not** match, **immediately** call the Clerk of Court's Office or voting machine warehouse technician and do not proceed further unless authorized to do so.

Figure 4: Voting Machine Serial Number



4.02: Verify Election Supplies

- A. If you have the correct voting machines for your precinct, open the **Supply/Lead Voting Machine** and make sure it contains all the supplies needed for the election.
- B. There should be a **Green Canvas Bag** in the **Supply/Lead Voting Machine** with two (2) items inside for all **STATE AND LOCAL ELECTIONS** labeled as:
 1. **General Forms Zipper Bag** (*Figure 5*); and
 2. **Precinct Specific Envelope (PSE)** (*Figure 6*).
- C. There should be three (3) items in the **Green Canvas Bag** for **FEDERAL ELECTIONS**:
 1. **General Forms Zipper Bag**;
 2. **Precinct Specific Envelope (PSE)**; and
 3. Braille Booklet and insert inside the **Braille Booklet Envelope (BBE)** (*Figure 60*).
- D. Rolls of tape are provided in the **Precinct Specific Envelope (PSE)** to secure documents to the wall.
- E. All general forms that can be used in any election are in the **General Forms Zipper Bag**.
- F. The **Audio Voting Unit** is located in the **Supply/Lead Voting Machine**.

Figure 5: **General Forms Zipper Bag**

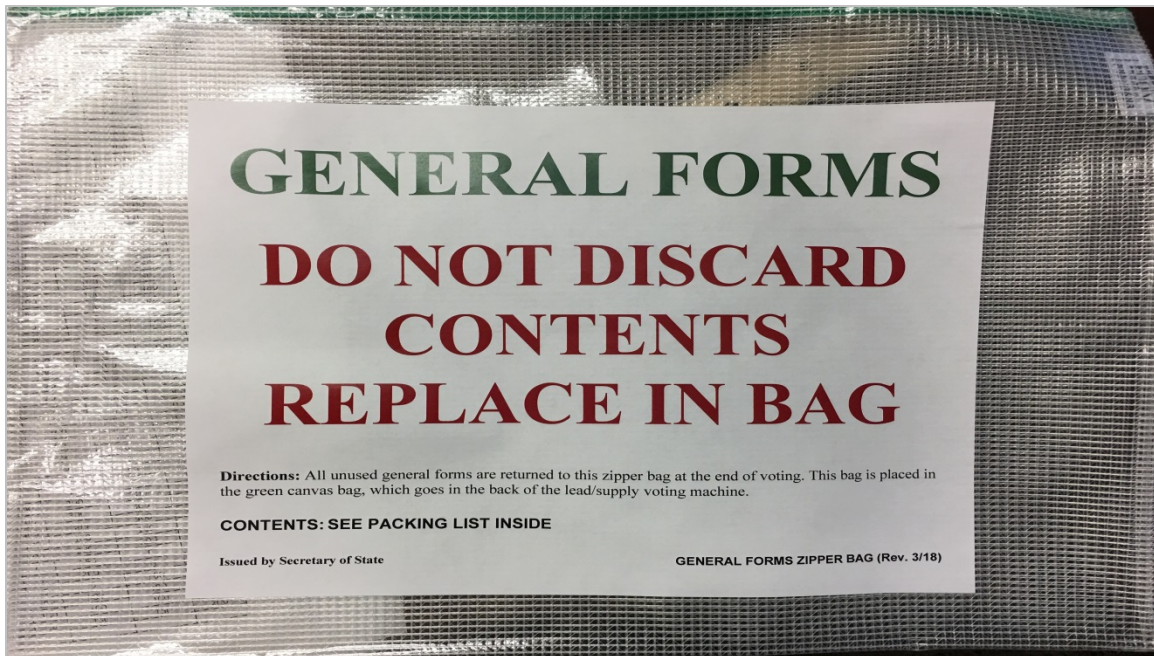

G. All precinct specific forms will be in the **Precinct Specific Envelope (PSE)**.

1. For FEDERAL ELECTIONS, the **Precinct Specific Envelope (PSE)** will also contain provisional voting supplies, including an **Election Day Provisional Packet**. Follow directions in *Part 10: Provisional Voting (Federal Elections Only)* for provisional voting.
2. Always open the **Election Day Provisional Packet** in Federal Elections.

Figure 6: Precinct Specific Envelope (PSE)

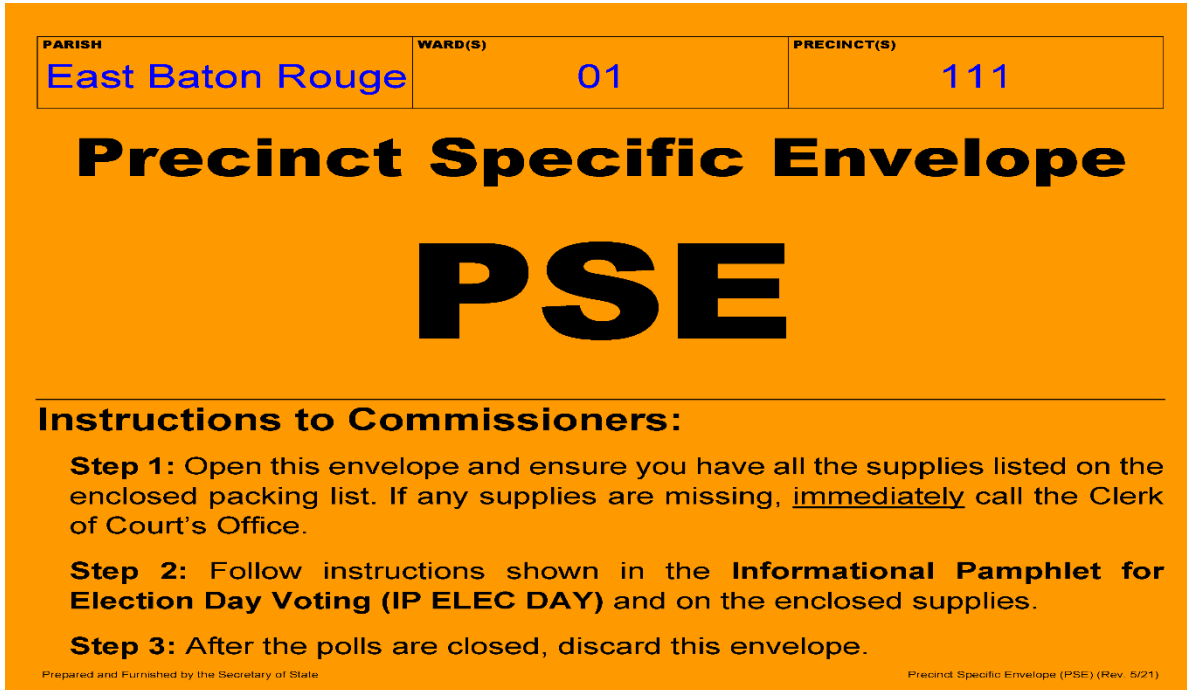

H. If you have materials for another precinct that were mistakenly delivered to your precinct or you are missing certain election materials, **CALL THE CLERK OF COURT'S OFFICE IMMEDIATELY** and make a written report of the issue on the **Notation of Irregularities Form** (*Figure 7*) located in the **Precinct Specific Envelope (PSE)**.

I. If there are any mechanical problems, supply problems (including security seals), or commissioner problems, **CALL THE CLERK OF COURT'S OFFICE IMMEDIATELY** and make a written report of the issue on the **Notation of Irregularities Form** located in the **Precinct Specific Envelope (PSE)**.

Figure 7: Notation of Irregularities Form



NOTATION OF IRREGULARITIES IN THE CONDUCT OF THE ELECTION

INSTRUCTIONS: USE A BALL POINT PEN – PRESS FIRMLY

Election Date: _____ **Parish:** _____ **Ward:** _____ **Precinct:** _____

Commissioners should make a notation of irregularities observed during the election, including but not limited to, (1) the security of the polling place or voting machines; (2) the physical condition of the voting machines or election materials; (3) if a voting machine's zero proof report does not register zero; (4) if seal numbers listed on the Key Envelope A do not match the seal numbers on the voting machine(s) or precinct register; and (5) any other matter affecting vote totals, such as if you have a "fled voter" who fails to make a selection and you therefore have more voters in the precinct register and poll list than the number of votes on the voting machine(s). Include your name, time, description, and resolution to any issue(s).

1. _____

2. _____

3. _____

4. _____

5. _____

6. _____

7. _____

Commissioner Signatures:

	_____ CIC Signature	_____ CIC Printed Name	
_____ Commissioner Signature	_____ Commissioner Signature	_____ Commissioner Signature	_____ Commissioner Signature
_____ Commissioner Printed Name	_____ Commissioner Printed Name	_____ Commissioner Printed Name	_____ Commissioner Printed Name

Disposition: Original (White) is put in the Clear Zipper Bag for delivery to the Clerk of Court, Duplicate (Yellow Copy) goes in the S-19 Secretary of State Envelope, and Duplicate (Pink Copy) goes in the ROV Registrar of Voters Envelope.

Prepared and Furnished by the Secretary of State NOI - Notation of Irregularities (Rev. 07/21)

4.03: Helpful Aids for the Voters

- A. In a clear plastic pocket located on the inside front door of the **Supply/Lead Voting Machine**, or in the **Green Canvas Bag**, there is a **Full Page Magnifier** and a **braille copy of the Guide to Using the Audio Voting Keypad**. Some voters with visual impairments may need the full page magnifier to better view the ballot on the voting machine or the Braille Booklet to assist them in using the audio unit. These items must be returned to the **Plastic Pocket** that is located inside the front door of the **Supply/Lead Voting Machine** or to the **Green Canvas Bag** at the end of voting.

- B. A **non-braille version Quick Chart Guide to Using the Audio Voting Keypad** is located in the **General Forms Zipper Bag** in the **Green Canvas Bag**. A voter does not have to be marked in the precinct register as needing assistance in order to use the full page magnifier or audio unit.

Part 5: Posting Election Information

5.01: What to Post at the Polling Place

- A. Once you have verified you have the correct voting machines and election supplies, post the following items in a visible place at the main entrance to the polling place prior to 7 a.m. on all Saturday elections and 6 a.m. on all Tuesday elections and keep them up throughout election day:
1. an **Election Date and Hours Poster (DH)** filled in with the election date and polling hours
 2. an **Accessible Entrance Sign (AE)** for voters with disabilities, filled in with directional arrows, if needed
 3. an **Election Day Louisiana Voters' Bill of Rights and Voting Information Poster (VBR-IP)**
 4. samples of the **Official Ballot**
 5. an **Official Election Zero Proof Report** printed from each voting machine
 6. a **Stop Sign Electioneering Warning Poster (EW-1WN)**
 7. a **Statement of Proposed Constitutional Amendments** poster, if there are any constitutional amendments on the ballot
 8. a **Notice to Voters: Picture ID Poster (NV-ID)**.
- B. Post the following items by the precinct register:
1. **Notices of Candidate Disqualifications, Withdrawals, or Candidate Deaths (PCT-NOTICE)**: If the clerk of court authorizes the commissioner-in-charge to post a **PCT-NOTICE**, the notice shall be posted near the precinct register during the entire course of the election.
 2. **Voter Registration Applications (LA-VRA)** are required to be placed by the precinct register for applicants to register to vote, correct a name misspelling, or make any changes to their voter registration record, including a request for assistance in voting. Place all completed **Voter Registration Applications (LA-VRA)** in **ROV (Registrar of Voters Envelope)**.

Part 6: Inspecting and Operating Voting Machines

6.01: Inspection of the Voting Machines

- A. You may remove the **Machine Certificates (MC-52)** (Figure 31) from the **Precinct Specific Envelope (PSE)** before you begin your inspection and list the serial numbers of the machines on the form, as indicated on the voting machine labels and **Key Envelope A**. If you observe any physical damage to any voting machines, please **IMMEDIATELY** notify the Clerk of Court's Office or voting machine warehouse and make a notation of the damage on **Certificate No. 1** of the **Machine Certificates (MC-52)**.
- B. **Open the back of every voting machine!**
- C. Compare the cartridge seal numbers recorded on the **Key Envelope A** with the **red seals** on the clear protective cover over the **Blue Results/Audio Cartridge** (Figure 8) that is located in the back of each voting machine. Write the seal numbers on **Certificate No. 1** of the **Machine Certificates (MC-52)** that correspond to the appropriate voting machine. If these numbers do not match, call the Clerk of Court's Office or voting machine warehouse technician **IMMEDIATELY** and make a written report of the issue on the **Notation of Irregularities Form** located in the **Precinct Specific Envelope (PSE)**.
- D. You will compare the public and protective counter numbers recorded on the **Key Envelope A** with the public and protective counter number on the operator panel display later in this process.

Figure 8: Blue Results/Audio Cartridge

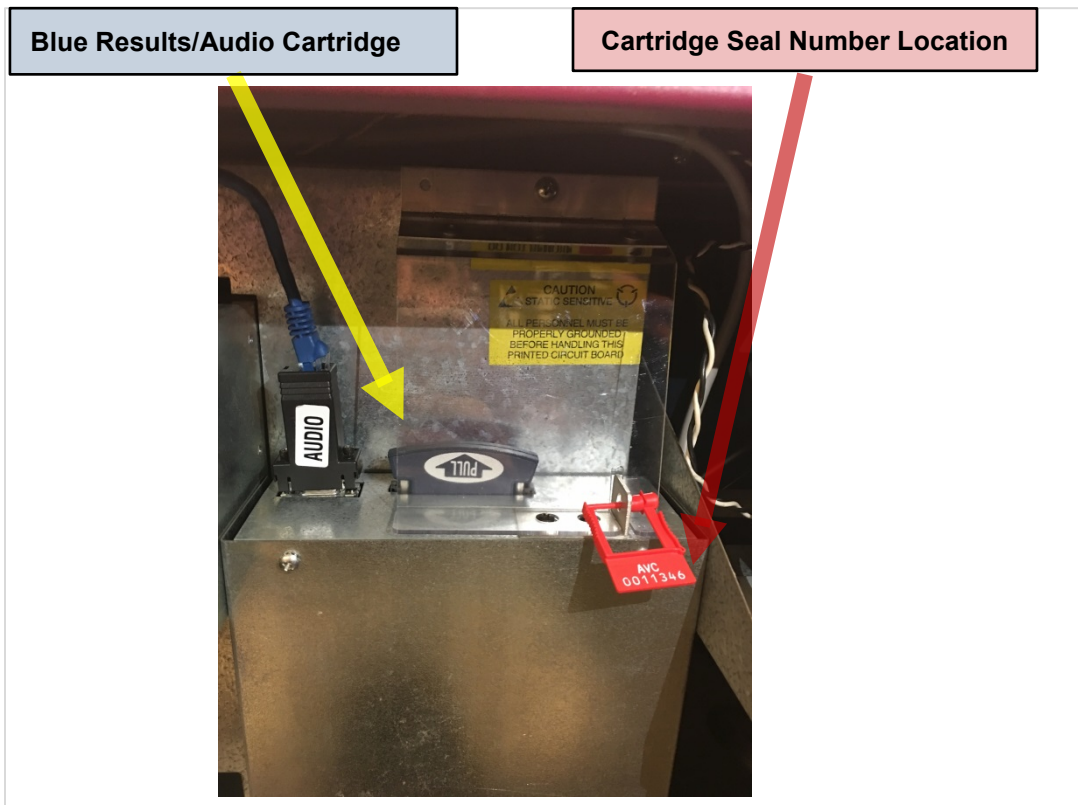

6.02: Inspection of the Precinct Register Seals

- A. Once the voting machines are inspected, get the precinct register(s) from the back of the **Supply/Lead Voting Machine** and compare the precinct register seal(s) on the precinct register(s) with the precinct register seal number(s) listed on the **Key Envelope A**.
- B. If the seal numbers match, then write the seal number(s) on **Certificate No. 1** of the **Machine Certificates (MC-52)**.
- C. If these numbers do not match, call the Clerk of Court's Office or voting machine warehouse technician **IMMEDIATELY** and make a written report of the issue on the **Notation of Irregularities Form** located in the **Precinct Specific Envelope (PSE)**.

6.03: Setting up the Voting Machines

- A. Position the voting machine next to an electrical wall outlet in a location convenient for use by you and the voters. Keep in mind accessibility for voters with disabilities.
- B. Lock the two back wheels (*Figure 9*) in place by pressing your foot down on the back of each brake.
- C. Remove the plastic cover.
- D. Pull out the power cord and plug it into an electrical outlet. Be careful not to pull the cord out too far.
- E. Once plugged in, the **yellow power indicator light** located to the left of the power cord must show **yellow**. If it does not, locate and try a different electrical outlet.

Figure 9: Positioning Voting Machine

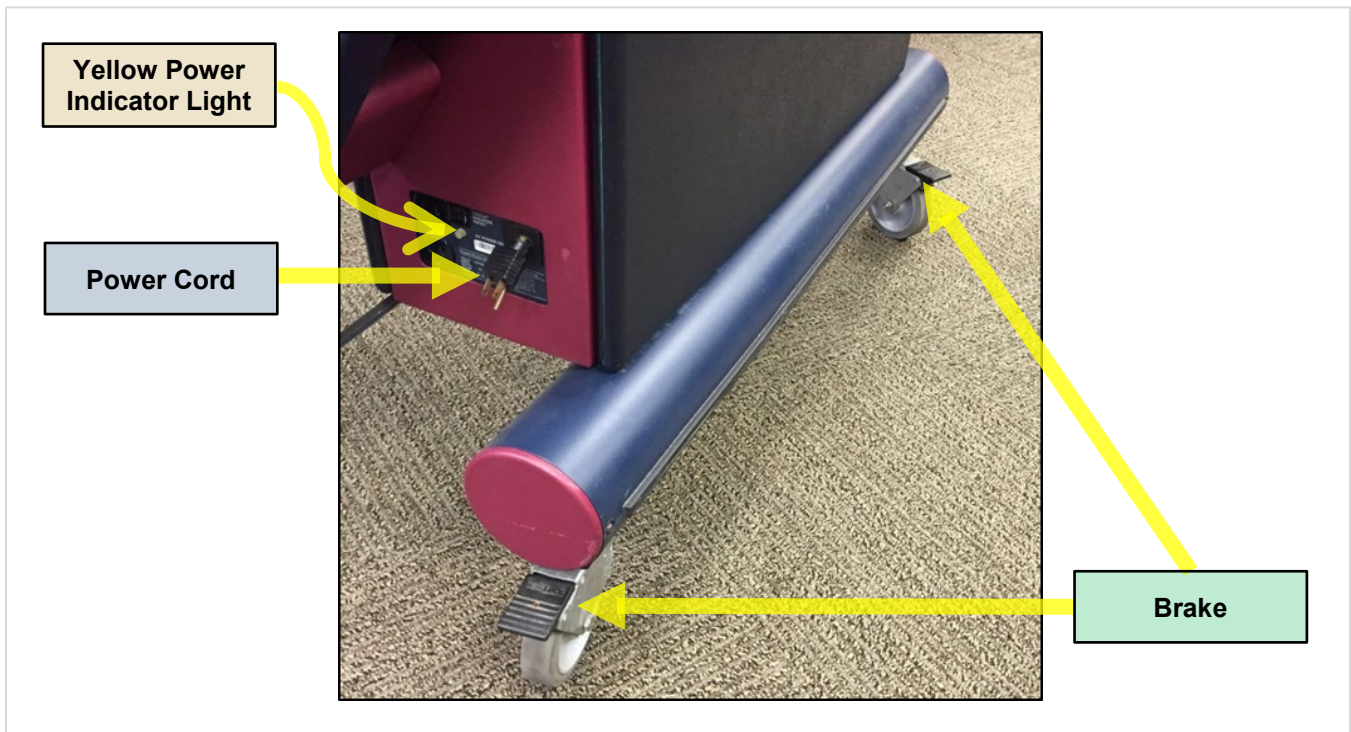

F. If you have multiple voting machines, use the daisy-chain method (*Figure 10*) to connect them.

Figure 10: Daisy Chain Set-up

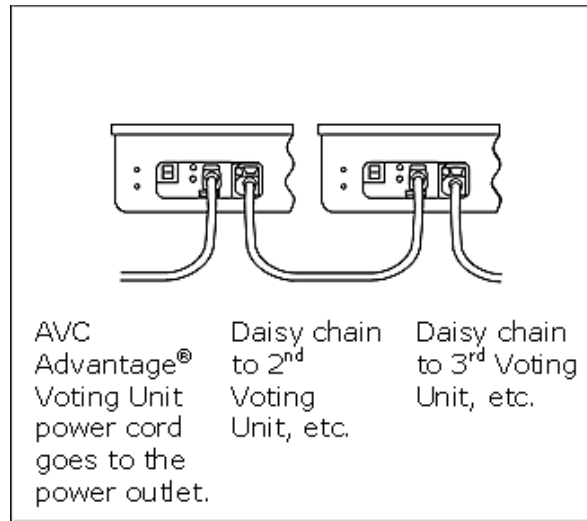

G. Connect each voting machine to the previous unit's power receptacle (AC IN).

H. Make sure that the **yellow power indicator light** is on for each voting machine.

6.04: Turning the Voting Machine Power "ON"

A. Using the **yellow-capped key**, unlock the back door (if it was re-locked after step 6.01) by turning the key clockwise. Remove the operator panel (*Figures 11 & 12*) from the back and hang it to either side of the voting machine.

Figure 11: Operator Panel within Back of Unit

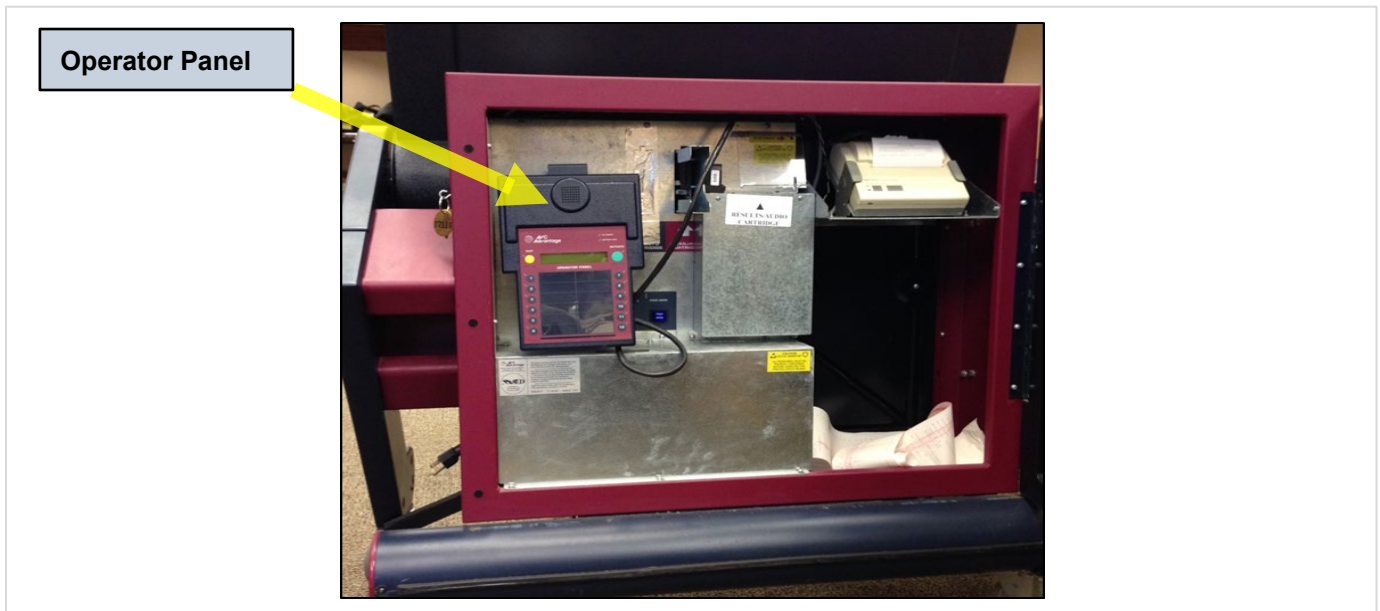
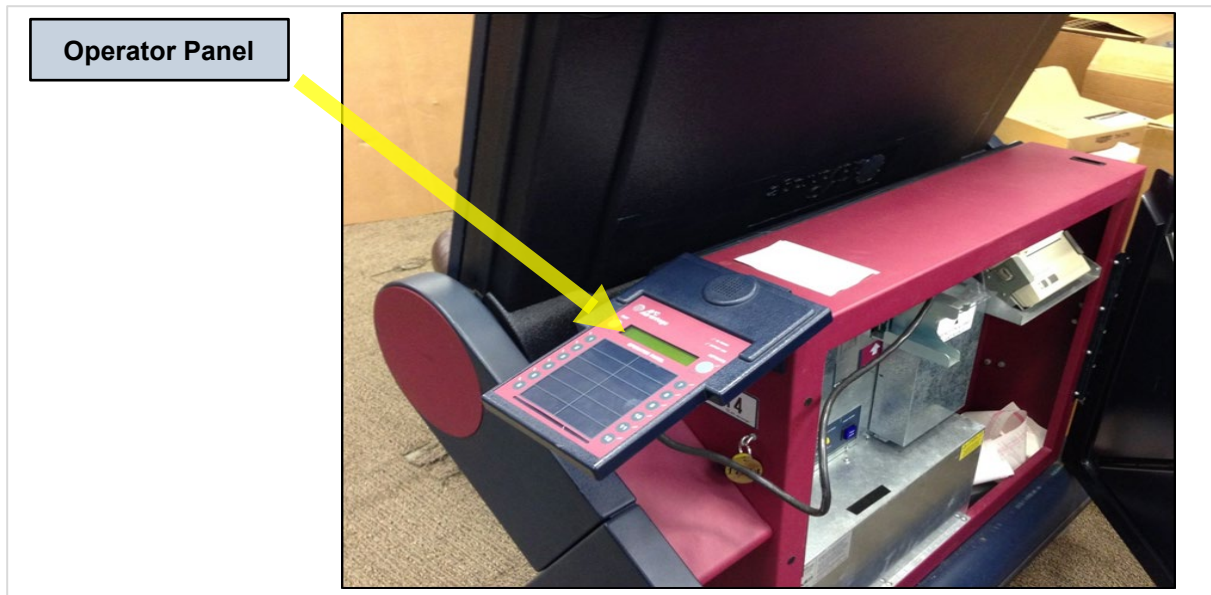
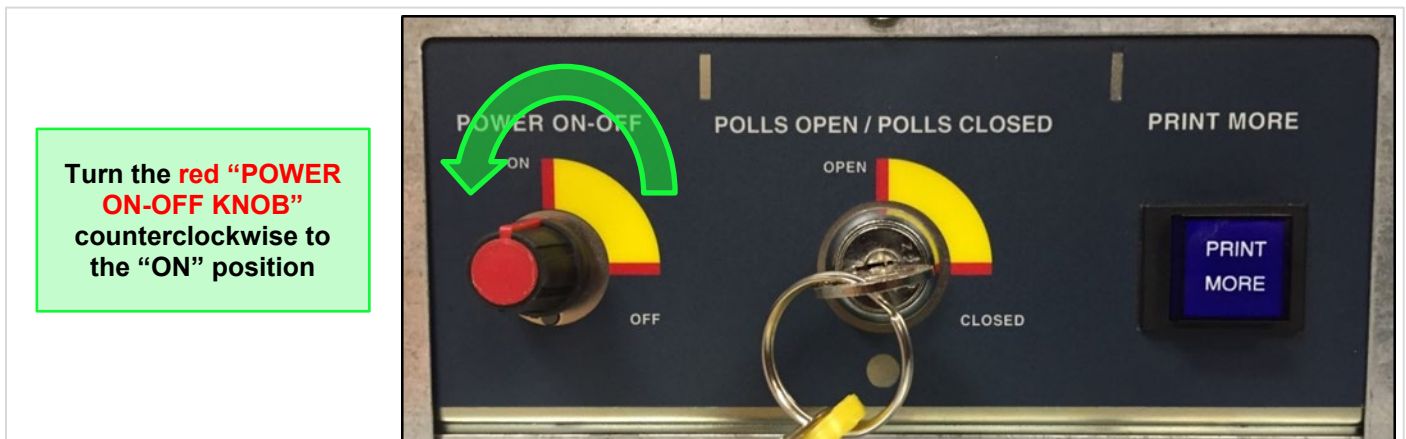

Figure 12: Operator Panel in Position



- B. Turn the red **“POWER ON-OFF KNOB”** to the “ON” position (*Figure 13*). Please wait for the voting machine to COMPLETELY power up. **Turning the voting machine’s power “On” & “Off” does not require a key!**

Figure 13: Power On-Off Button



Turn the red **“POWER ON-OFF KNOB”** counterclockwise to the “ON” position

- C. Once the voting machine is completely powered on, compare the public and protective counter numbers on the operator panel display (*Figure 14*) to the numbers on the **Key Envelope A**. If the numbers match, enter the numbers on **Certificate No. 1 of the Machine Certificates (MC-52)**. If these numbers do not match or if the public counter is not zero, call the Clerk of Court’s Office or voting machine warehouse technician **IMMEDIATELY** and make a written report of the issue on the **Notation of Irregularities Form**.

6.05: Opening the Polls

- A. Once the voting machine has completely powered up, the operator panel display should read **“READY TO OPEN POLLS ELECTION.”**

Figure 14: Operator Panel - “Ready to Open Polls”

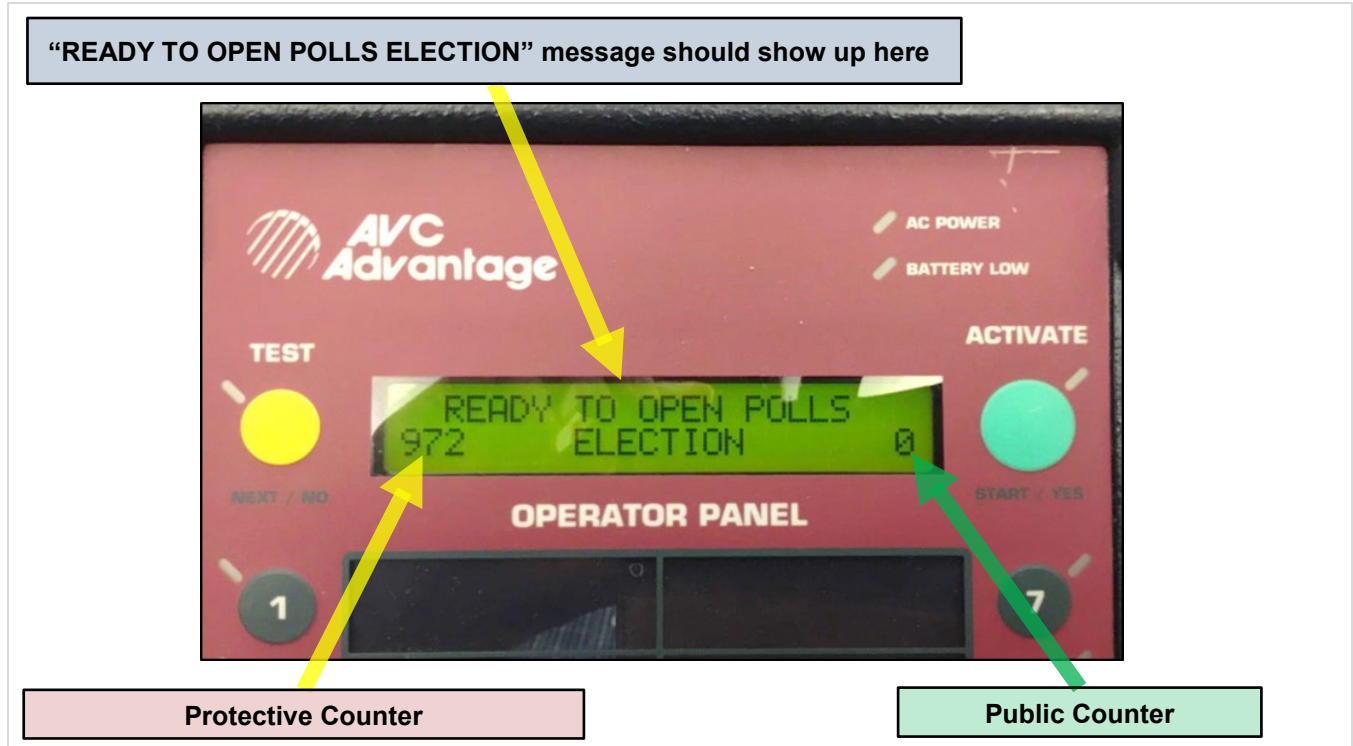

- B. If the panel reads **“READY TO OPEN POLLS ELECTION,”** go to the back of the voting machine and insert the small **silver key** into the **“POLLS OPEN/POLLS CLOSED”** slot and turn to the **“OPEN”** position (*Figure 15*). Remove the key and place in the **B-02 Key Envelope**.
- C. If the **“READY TO OPEN POLLS ELECTION”** message does not display, notify the Clerk of Court’s Office or voting machine warehouse technician **IMMEDIATELY** and make a written report of the issue on the **Notation of Irregularities Form**.

WARNING: DO NOT TURN THE KEY BACK TO THE “CLOSED” POSITION. REMOVE THE KEY IMMEDIATELY AFTER TURNING THE POLLS TO OPEN. YOU WILL ONLY USE THIS SILVER KEY AGAIN WHEN IT IS TIME TO CLOSE THE POLLS.

Figure 15: Opening Polls Diagram

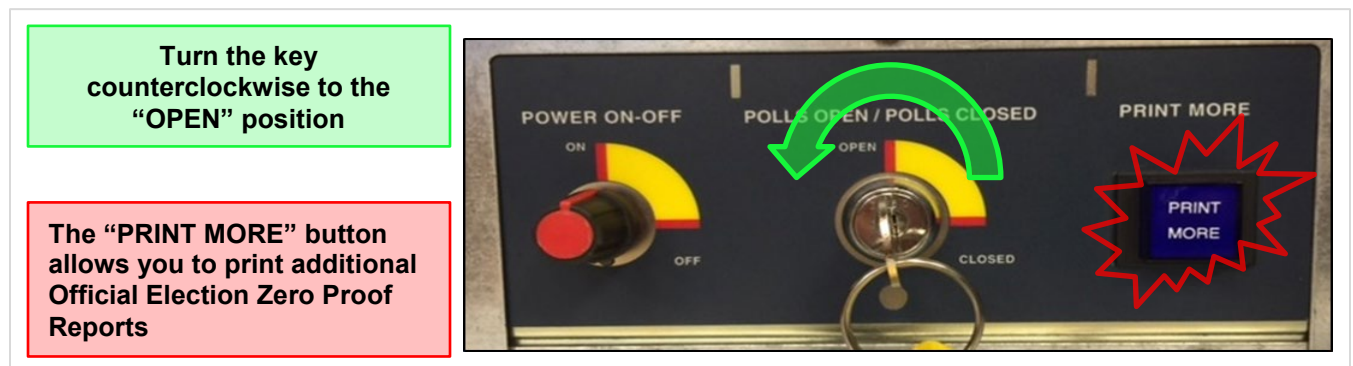

- D. When the polls are opened, the operator panel reads “**VOTER INACTIVE POLLS OPEN**” (Figure 16) and an **Official Election Zero Proof Report** (Figure 17) will automatically print one (1) copy. Check the time as the report begins to print. If the time on the report is incorrect, make a notation on the **Notation of Irregularities Form** and call the Clerk of Court’s Office.
- E. If the clerk of court requires more than one copy of the **Official Election Zero Proof Reports**, you must print these now by pressing the “**PRINT MORE**” button.
- F. Check the **Official Election Zero Proof Reports** and make sure there is a zero by each candidate or proposition listed and a zero by the public counter. Compare the report to the sample of the official ballot and the actual ballot on the face of the voting machine to make sure all ballot information is the same. Verify that the ward and precinct are correct. If the information is correct, complete item 6 on **Certificate No. 1** of the **Machine Certificates (MC-52)**. If the information is not correct, call the clerk of court **IMMEDIATELY** and make a written report of the issue on the **Notation of Irregularities Form**.
- G. After verifying all information, all commissioners must sign and date the **Official Election Zero Proof Reports**, and post them at the entrance to the polling place.
- H. If there are any mechanical, supply (including protective seals), or commissioner problems, call the Clerk of Court’s Office **IMMEDIATELY** and make a written report of the issue on the **Notation of Irregularities Form**.

Figure 16: Operator Panel Diagram

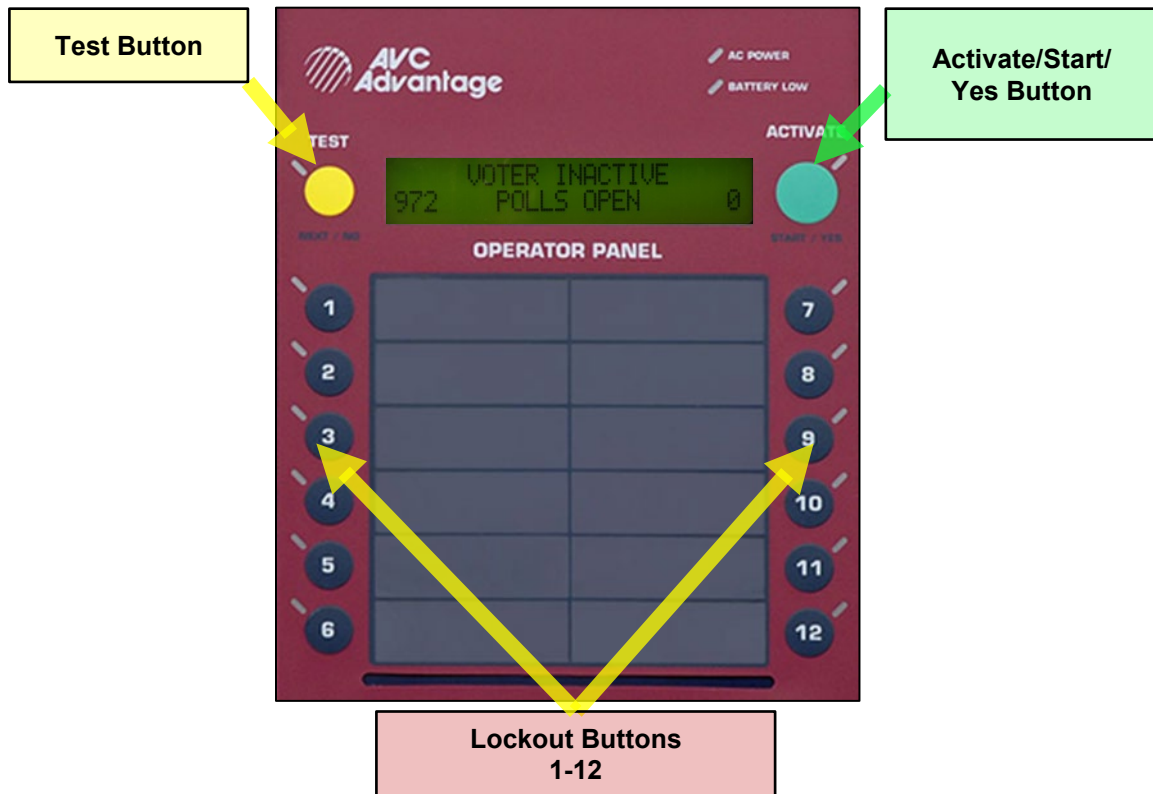

Figure 17: Official Election Zero Proof Report

```

*****
OFFICIAL ELECTION ZERO PROOF REPORT
*****
Date      4/5/2016                Time    6:40
Serial Number      1167
Protective Counter 1125
Public Counter     0
Precinct/District
  WARD 1 Precinct 32 B
Polling Place ID   1033202
Ballot Version
Report Source Internal      Machine Memory
EAST BATON ROUGE PARISH
GENERAL ELECTION
APRIL 5, 2016

Candidate Totals
Candidate          ***          Total
***              ***          ***
*  LAW ENF DS PROP          (1)
  C2
D12  YES                0
D13  NO                 0
*  P/W MET CNCL PROP 1     (1)
  C14
D24  YES                0
D25  NO                 0
*  P/W MET CNCL PROP 2     (1)
  E2
F13  YES                0
F14  NO                 0

Write In Votes
No Write In Votes In Memory

Election Officers
Please Complete Before
Processing the First Voter
We the undersigned Election Officers do
hereby certify that on the  5
day of  April  20  16  the Public
Candidate, and Question Counters were
found to be zero and the Protective
Counter read 1125 before the Polls
were Opened.

Signed:
_____  

Joseph King
_____  

Janet Lee
_____  

Sharon Law
_____  

Louis Black

```

1. Verify time.

2. Verify serial # of voting machine.

3. Verify Protective Counter #.

4. Make sure Public Counter is zero.

5. Verify the ward/precincts are correct.

6. Verify that all candidate and/or proposition counters are zero.

7. Fill in the correct date.

8. All commissioners MUST sign report and post it with other materials near principle entrance of the polling location.

6.06: Rotating the Voter Panel to the Voting Position

- A. As the voting machine voter panel is swung upward, it will pause at intermittent points unless the **maroon latch** is pulled (*Figure 18*).

Figure 18: Positioning the Voter Panel to the Vertical Position (Part 1)



- B. The voter panel will stop in a vertical position (*Figure 19*). This is the position to use for voters who have to be seated while casting their ballot, either in a chair or wheelchair.

Figure 19: Positioning the Voter Panel to the Vertical Position (Part 2)

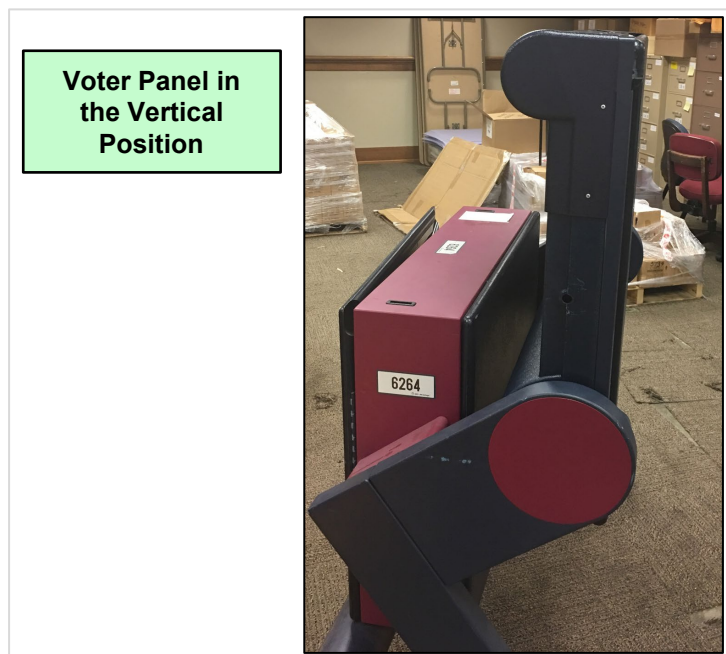

- C. Go to the back of the voting machine and pull the **maroon latch** to tilt the voter panel until it is resting on the back of the voting machine; this is the upright voting position to use for all voters, except those who have to be seated as described above (*Figure 20*).

Figure 20: Pull Maroon Latch on Tub and Tilt to the Upright Voting Position



6.07: Front Doors and Curtain

- A. Go to the front and open the door panels using the **yellow-capped key**, turning counterclockwise (*Figure 21*).

Figure 21: Open Side Door Panels



- B. Carefully raise the top white panel with one hand, and move a side panel into place. Carefully adjoin it with the bracket on the inside top of the panel and then adjoin the second panel. If you apply too much force, the adjoining catch may be damaged (*Figure 22*). (When possible, you may want to have another commissioner assist with this step. One commissioner can hold the top white panel in place while the other is securing the side panels.)

Figure 22: Connect the Top Panel with Side Panels

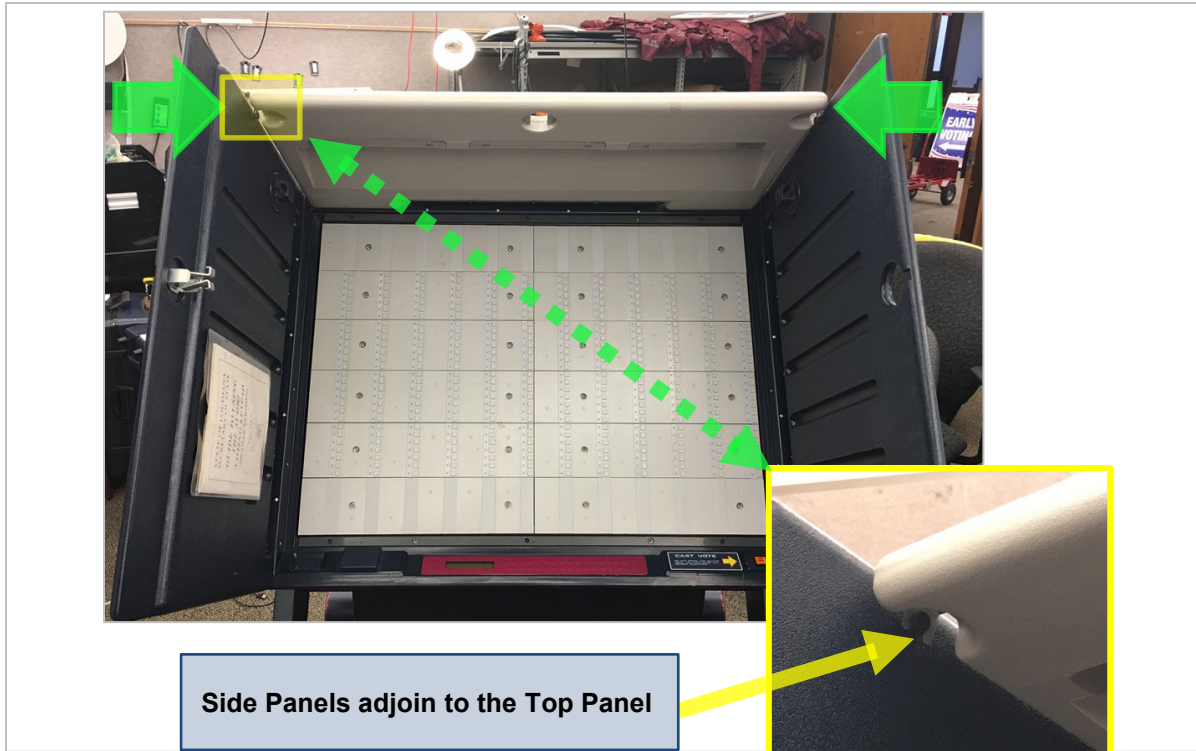

- C. Retrieve the privacy curtain from the storage tube located at the bottom of the voting machine (*Figure 23*). To do this, push in one of the small release buttons, pull the cap off, and remove the curtain.

Figure 23: Privacy Curtain - Location

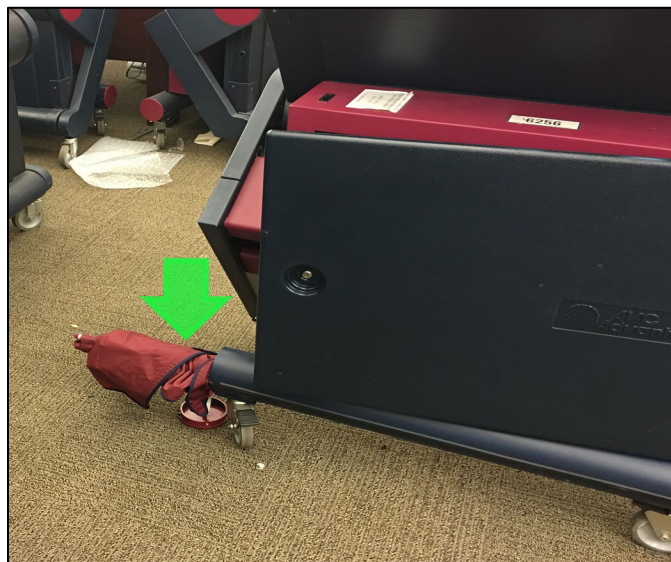

- D. Unroll the curtain and open the frame into a U shape.
- E. Move to the front of the voting machine and push the arms of the curtain frame through the open brackets on the inside of the front panels. The curtain arms rest on these brackets and do not snap into place (*Figures 24 & 25*).

Figure 24: Privacy Curtain - Installation

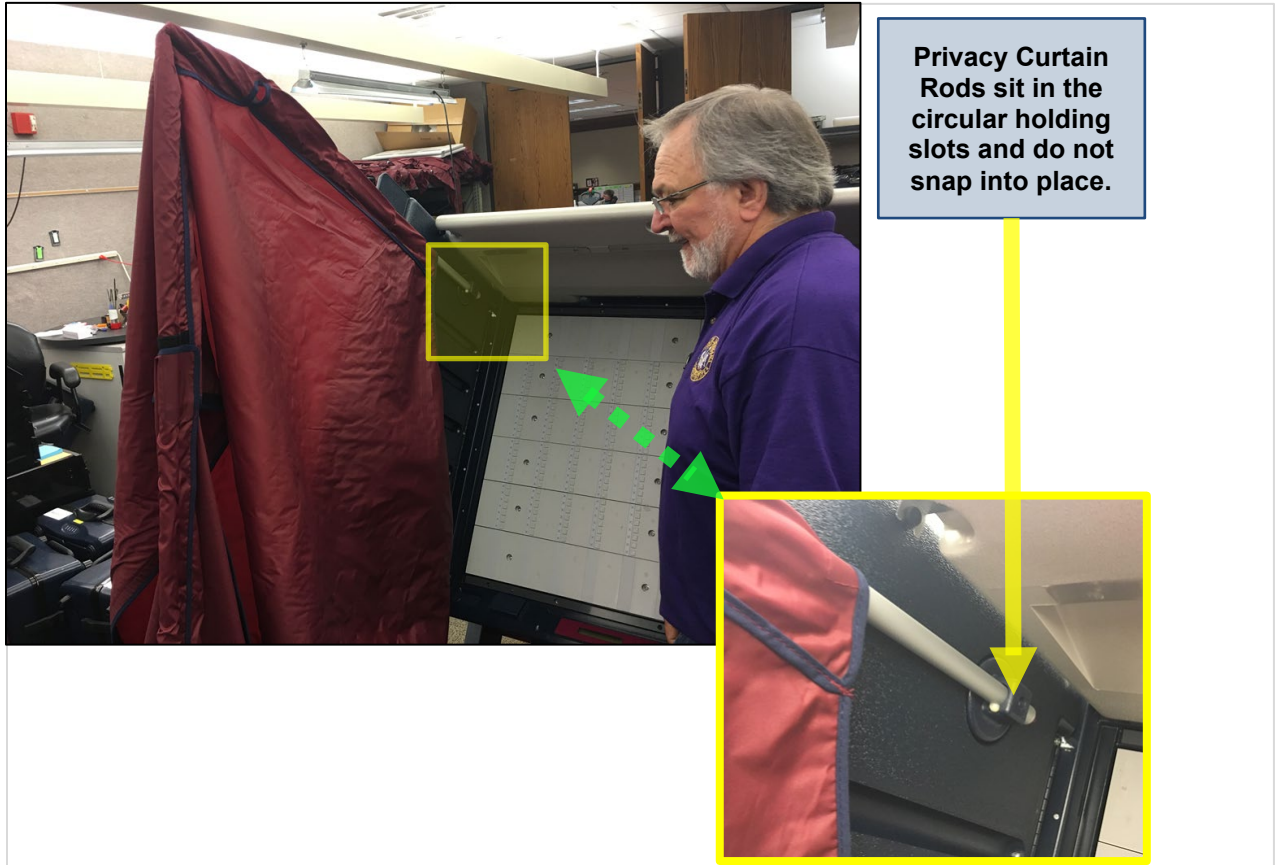
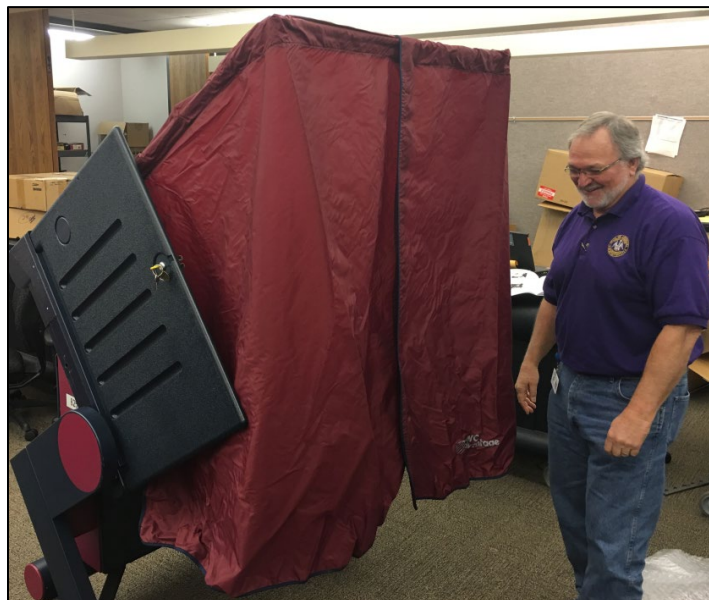

Figure 25: Privacy Curtain - Installed



6.08: Audio Unit

- A. Remove the **Audio Unit Bag** (*Figure 26*) from the **Lead/Supply Voting Machine** and place it on the top corner opposite the operator panel. The **Audio Unit** **MUST** be set up by the commissioners in accordance with La. R.S. 18:553(B)(4) and may be used by ANY voter, especially those voters needing assistance due to any disability, visual or physical, including those who struggle with the written word.
- B. Inspect the audio voting accessory components in the bag to ensure all items shown in *Figure 26* are included.
- C. Make sure the **Audio Unit** is connected to the back of the voting machine (*Figure 27*).

Figure 26: Audio Unit



Figure 27: Connect Audio Unit to the Back of the Voting Machine



6.09: Closing the Back of Machine

When closing the back door, make sure the cord leading to the operator panel goes through the groove in the upper corner inside the back door (Figure 28).

Figure 28: Closing Back Panel Door and Cord Groove Location



6.10: Voting Machine Keys

- A. In the presence of the watchers, place all keys in the **B-02 Key Envelope** (Figures 29 & 30), and then all commissioners must sign the envelope and seal it. Do not open this envelope until voting is complete (8 p.m. or until the last voter has voted), or if the Clerk of Court's Office or voting machine technician instructs you to do so to assist in operation of the voting machine due to a system error.
- B. Please document your actions in writing on the back of the **B-02 Key Envelope**, date, and sign.

Figure 29: B-02 Key Envelope (Front)

VOTING MACHINE KEY ENVELOPE (DURING ELECTION)		
PARISH	WARD	PRECINCT
East Baton Rouge	01	21C
<p>BEFORE election, Commissioners fill in voting machine number in blanks and sign below.</p> <p style="text-align: center;"> 11667 11668 11669 </p> <p style="text-align: center;"> _____ _____ _____ </p> <p style="text-align: center;"> _____ _____ _____ </p>		
<p>We hereby certify we have sealed in this envelope the keys which belong to the VOTING MACHINES NUMBERED ABOVE:</p>		
COMMISSIONER _____	COMMISSIONER _____	COMMISSIONER _____
<i>Jon Snow</i>	<i>John Doe</i>	<i>Jen Snow</i>
COMMISSIONER _____	COMMISSIONER _____	COMMISSIONER _____
<i>Jane Doe</i>	<i>Laura Noftall</i>	
COMMISSIONER-IN-CHARGE _____		
<p>DURING election, Commissioners keep this envelope sealed. →→→→ KEYS SEALED DURING VOTING</p> <p>If keys to the voting machine are needed during the election by an election official for repair, execute certificate on back of envelope.</p>		
<p>AFTER election, Commissioners remove keys to close voting machines. Put this envelope in the C-03 envelope if any machine was opened for repair. If no machine was opened for repair, please discard this envelope.</p>		
<p>B-02 (Rev. 6/15) Issued by SECRETARY OF STATE</p>		

Figure 30: B-02 Key Envelope (Back)

FOR USE BY ELECTION OFFICIALS ONLY

This envelope was opened by John Doe on 01/01/16 at 7:00 a.m.
(name) (date) (time)

for repair of voting machine number 11887. The keys were replaced at 7:30 a.m.
(time) (time)

John Doe (Technician)
(signature) (election official title)

This envelope was opened by _____ on _____ at _____,
(name) (date) (time)

for repair of voting machine number _____. The keys were replaced at _____.
(time)

(signature) (election official title)

This envelope was opened by _____ on _____ at _____,
(name) (date) (time)

for repair of voting machine number _____. The keys were replaced at _____.
(time)

(signature) (election official title)

This envelope was opened by _____ on _____ at _____,
(name) (date) (time)

for repair of voting machine number _____. The keys were replaced at _____.
(time)

(signature) (election official title)

6.11: Voting Machine Certificate (MC-52) No. 1

- A. Ensure **Certificate No. 1** of the **Machine Certificates (MC-52)** (*Figure 31*) is completed by making the following notations on the certificate if they have not already been made during the inspection process including:
1. the exact time the keys to the voting machines were delivered by the clerk of court or deputy custodian to the commissioner-in-charge
 2. the voting machine serial number of each voting machine from the permanent label on the top or side of the machine
 3. the cartridge seal number for each **Blue Results/Audio Cartridge** of every voting machine
 4. the number shown for the **public counter number** (number on the right side of the operator panel display) of each voting machine (*all public counter numbers should be zero*)
 5. the number shown for the **protective counter number** (number on the left side of operator panel display) of each voting machine
 6. any visible damage to a voting machine, by serial number, prior to the start of the election
 7. verification that the **public counter numbers** on all the **Official Zero Proof Reports** have zeros and that the ballot information matches the sample ballot that was packed in the **Precinct Specific Envelope (PSE)** and the AVC ballot on the machine face. If it does, write "Yes." If it does not, write "No" and **immediately** contact the Clerk of Court's Office
 8. Compare the precinct register seal number(s) listed on the **Certificate No. 1**.

Figure 31: Machine Certificate No. 1

Machine Certificate No. 1

MACHINE CERTIFICATES - MC-52

INSTRUCTIONS: USE A BALL POINT PEN - PRESS FIRMLY

WE THE UNDERSIGNED COMMISSIONERS for WARD 01, PRECINCT 01, PARISH OF East Baton Rouge, STATE OF LOUISIANA, hereby certify that we have recorded and verified the following information in accordance with the provisions of the election code.

I. CERTIFICATE NO. 1 - FILLED IN AT THE OPENING OF POLLS

1. At <u>6:30</u> a.m., voting machine keys were delivered. Key numbers were compared to machine serial numbers. Machine serial numbers were the following:	Serial #	1167	1168	1169	1170	MACHINE	MACHINE	MACHINE	MACHINE
2. SEAL NUMBERS were compared to cartridge seal number on the Key Envelope A. Cartridge seal numbers were the following:	Seal #	1111	2222	3333	4444				
3. PUBLIC COUNTER NUMBERS (right side of the operator panel) were the following (should be zero):	Public Counter #	0	0	0	0				
4. PROTECTIVE COUNTER NUMBERS (left side of the operator panel) were the following:	Protective Counter #	1125	1000	1100	1200				
5. List any visible damage prior to the start of the election to a voting machine by serial number:	Visible Damage	None	None	None	None				
6. Check the Official Zero Proof Reports to make sure all are zeros (000) and then compare report to sample ballot and AVC ballot on the machine face to confirm they are the same. (Yes or No).....	Report, Sample & AVC Ballot Match? (Yes/No)	Yes	Yes	Yes	Yes				

7. The Precinct Register was delivered with seal number(s): 547651

II. CERTIFICATE NO. 2 - FILLED IN AT THE CLOSING OF POLLS

1. At _____ p.m., voting machines were closed against further voting. Serial numbers on machines closed were the following:	Serial #					MACHINE	MACHINE	MACHINE	MACHINE
2. PUBLIC COUNTER NUMBERS (right side of the operator panel) shown were the following:	Public Counter #								
3. PROTECTIVE COUNTER NUMBERS (left side of the operator panel) were the following:	Protective Counter #								
4. List any visible damage at the close of the election to a voting machine by serial number that occurred during the election:	Visible Damage								

5. The Precinct Register was resealed by the commissioners at the end of the election with seal number(s): _____
 6. After locking machines, place voting machine keys into the C-03 Envelope, sign, and deliver to the clerk of court in the Clear Plastic Zipper Bag.

III. COMMISSIONER CERTIFICATION - SIGNED AFTER COMPLETION OF BOTH CERTIFICATES

IN WITNESS WHEREOF, we have signed our names at _____ p.m., on the _____ day of _____, 20____.

Commissioner-in-Charge Signature: _____ Commissioner's Signature: _____
 Commissioner's Signature: _____ Commissioner's Signature: _____

DISTRIBUTION: Original (white) is delivered to the Clerk of Court in the Clear Plastic Zipper Bag, the yellow is put into the S-19 (Secretary of State Envelope), and the pink is put in the ROV Envelope (Registrar of Voters Envelope).
 Prepared and Furnished by Secretary of State
 Machine Certificates (MC-52) Rev. 1/19

Part 7: Election Day Procedures

7.01: Preparing to use the Precinct Register

- A. Cut the **red seal** on the precinct register and place the cut **red seal** in the **Green Canvas Bag**. There will be a new **blue seal** in the precinct register for resealing the precinct register after the polls close. If at first you do not see the new **blue seal**, look in the bottom of the **Green Canvas Bag** as it may have fallen out of the precinct register binder.
- B. Please do not tape or clip anything to the precinct register. If you need to notify the Clerk of Court's Office about something, make a note and deliver the note on election night to the clerk of court in the **Clerk's Clear Plastic Zipper Bag**.
- C. There are tabs in the precinct register for specific information. There is a Supplemental Tab, a Precinct Register Correction Affidavit Tab, a Provisional Voters Tab, and an Assistance to Voters Tab.
 1. The **Supplemental Precinct Register Page** (Figure 32) or pages that go behind the tab are provided, as needed, in the **Supplemental List Envelope (L-SL)** (Figure 2).

Figure 32: Supplemental Precinct Register Page

Ward: 00		Precinct: 001		PctBallot: 1		Election Date: 5/3/2014		Parish:		Page: 1	
Voter Number	Name of Voter	Signature	Comm Initials	Barcode	Address (DOB) Mother's Maiden Name	Lockout Districts	S	R	A	P	
							E	C	S	R	
1	ABOAGYE →				Johns	1 - BUTTON 1	F	O		DEM	
2	ABRAHAMS →				Jones	3 - BUTTON 3	F	W		DEM	
3	ADAMS →				Lewis	7 - BUTTON 7	F	W		DEM	
4	ADAMS →				Henry	7 - BUTTON 7	F	W		REP	
5	ADAMS →				Snow	7 - BUTTON 7	M	W		NOPTV	

Check ALL Update

2. The **Precinct Register Correction Affidavit Page** (Figure 33), behind the tab, is used when a **Precinct Register Correction (PRC) Form** (Figure 38) is completed before voting. This page is blank for the commissioner to print the voter's name when the voter's name does not appear in the precinct register or the supplemental precinct register and the voter is allowed to vote by completing the **Precinct Register Correction (PRC) Form**. Only the registrar of voters or Secretary of State's Office may authorize the use of a **PRC**, and they will provide the button number if the voter has a lockout.

Figure 33: Precinct Register Correction Affidavit Page

Precinct:		PctBallot:		Election Date: 5/3/2014		Parish: EAST BATON ROUGE - 17		Page:		
Voter Number	Name of Voter	Signature	Comm Initials	Barcode	Address (DOB) Mother's Maiden Name	Lockout Districts	S	R	A	P
							E	C	S	R
1	John Doe →	<i>John Doe</i>	RP	N/A	123 Main St, BR, LA 70808		M	W	Y	
2	Jane Doe →	<i>Jane Doe</i>	RP	N/A	1 Abbey Lane, BR, LA 70808		F	O		
3	→									
4	→									
5	→									
6	→									

- The **Precinct Register Provisional Voter Page** (Figure 34), behind the tab, is only used in federal elections when a person votes a paper provisional ballot. The precinct register behind this tab is blank so the commissioner can print the voter’s information and have the voter sign before voting a paper provisional ballot.

Figure 34: Precinct Register Provisional Voter Page

Precinct:		PctBallot:		Election Date: 5/3/2014		Parish: EAST BATON ROUGE - 17		Page:			
Voter Number	Name of Voter	Signature	Comm Initials	Barcode	Address DOB Mother's Maiden Name	Lockout Districts	S E X	R A C E	A S S T	P R O V	
1	N/A John Doe →	<i>John Doe</i>	RP	N/A	123 Main St, BR, LA 70808		M	W	Y		
2	N/A Jane Doe →	<i>Jane Doe</i>	RP	N/A	1 Abbey Lane, BR, LA 70808		F	O			
3	→										
4	→										
5	→										
6	→										
7	→										
8	→										
9	→										

- The **Precinct Register Assistance to Voters Page** (Figure 35), behind the tab, is used when a voter receives assistance in voting. This page is blank for the commissioner to print the voter’s name and assistant’s name, and to have the assistant sign. The commissioner also checks the box in the first column if the voter in the precinct register does NOT have a “Y” for “Yes” under the “ASST” column. If there is no “Y” in the “ASST” column, but the voter is authorized by the commissioner to receive assistance either because the voter is unable to read or has a physical disability with supporting documentation discussed in Section 7.12 Disability Documentation, the commissioner checks the box indicating that there is no “Y” in “ASST” column but the voter was allowed assistance.

Figure 35: Precinct Register Assistance to Voters Page

Assistance to Voters					
Ward:	Precinct:	PctBallot:	Election Date:	Parish:	Page:
No 'Y' in ASST Column for Voter	Print Voter's Name	Print Assistant's Name	Signature of Assistant		
<input type="checkbox"/>	Jon Williams	Glenn Helpsolot	<i>Glenn Helpsolot</i>		
<input type="checkbox"/>	James Jones	Henry White	<i>Henry White</i>		
<input checked="" type="checkbox"/>	Saul Rosenberg	Sammy Watts	<i>Sammy Watts</i>		
<input type="checkbox"/>	Peter Griffin	Meg Agora	<i>Meg Agora</i>		
<input type="checkbox"/>	Ari B. Canaan	Jack Black	<i>Jack Black</i>		
<input type="checkbox"/>	Ben Hur	Mira Distopia	<i>Mira Distopia</i>		
-	Check ALL	Update			

7.02: Supplemental List Envelope (L-SL)

- If the deputy custodian or clerk’s employee delivers a **Supplemental List Envelope (L-SL)** (Figure 2), open it immediately. The envelope may contain a list of people voting absentee-by-mail and/or a supplemental precinct register.

- B. If the envelope contains a **List of Persons Voting Absentee-by-Mail**, you must document this information in the precinct register as follows:
1. For each name on the **List of Persons Voting Absentee-by-Mail**, write, “voted absentee” in the place where the voter usually signs the precinct register; then write your initials beside the words “voted absentee.” The commissioner who marks the voters who voted absentee and places their initials in the precinct register should also place their initials on the supplemental list of persons voting absentee-by-mail.
 2. Additionally, if the registrar of voters receives an absentee ballot on election day from a member of the United States Service or a person who resides outside of the United States, the registrar of voters will call and instruct the commissioner-in-charge to mark “voted absentee” in the place where the voter usually signs the precinct register and the commissioner initials beside the words “voted absentee.”
 3. When you have finished documenting and updating the precinct register, place the **List of Persons Voting Absentee-by-Mail** back into the **Supplemental List Envelope (L-SL)**.
 4. Place the **Supplemental List Envelope (L-SL)** in the back of the precinct register to be returned to the registrar of voters when the polls close.
- C. If the envelope contains a **Supplemental Precinct Register**, add the supplemental register to the precinct register binder behind the divider tab marked, “Supplemental.” In order to open the precinct register binder, you must slide the release button in the center of the spine to open the binder rings. Be careful to secure your original precinct register pages in this process so that your alphabetical list of voters does not get out of order. **If you do not find a voter’s name in the original precinct register pages, make sure to check the supplemental precinct register pages, which are in alphabetical order by voter last name.**
- D. If you do not find a voter’s name in the original precinct register pages or in the supplemental precinct register pages, ask the voter if they may be registered to vote under a different name. If so, you may offer the voter a **Voter Registration Application (LA-VRA)** form to complete if they want to submit a name change to the registrar of voters, **but this in no way affects their right to vote as presently registered.**

7.03: Identification of Voters

- A. A person who desires to vote must give their name and address to a commissioner, who shall announce the voter’s name and address.
- B. The commissioners **SHALL IDENTIFY EVERY VOTER**, including spouses, family, or neighbors of the commissioners, in the presence and view of the bystanders by requiring the voter to submit a photo ID or sign an affidavit. The voter may submit
1. a Louisiana driver’s license;
 2. the LA Wallet digital driver’s license;
 3. a Louisiana special identification card issued by the Office of Motor Vehicles (OMV);
 4. a United States military identification card that contains the applicant's name and picture; or
 5. other generally recognized picture identification card that contains the name and the signature of the person trying to vote.

- C. **Do not remove an ID from a wallet**; if you cannot read it, ask the voter to remove it for you. If a voter accidentally leaves their ID or other personal belongings at the polls, return it to the clerk of court in the **Clerk's Clear Plastic Zipper Bag** along with all other information and election results after the polls are closed.
- D. LA Wallet digital driver's license should be accepted, but the commissioner **MUST** do so without handling the voters' device. Simply ask the voter to open LA Wallet on their device and show it to you. If you would like to see further validation that the license is actually in LA Wallet, you may ask the voter to show the security seal. The voter can press and hold the license on the screen to reveal the security seal. If you have doubts about the acceptability of any ID presented by the voter, have them complete a **Voter Identification Affidavit (AV-34)** (Figure 36).
- E. **DO NOT TURN AWAY A VOTER FOR LACK OF PHOTO ID.**
- F. If the voter does not have a photo ID, as specified above, the voter shall complete and sign a **Voter Identification Affidavit (AV-34)**. The applicant must include their name, address, date of birth, and mother's maiden name (unless unknown).
- G. If the applicant does not know their mother's maiden name and says such, have the applicant write "unknown" in that field.
- H. If the applicant is unable to read or write or cannot complete the affidavit due to a disability, they may receive assistance in completing the affidavit, and the commissioner shall make a notation on the affidavit that the applicant received assistance in completing the form.
- I. The commissioner should compare the name, address, date of birth, and mother's maiden name information on the **Voter Identification Affidavit (AV-34)** to all relevant information in the precinct register to determine if there are differences and to confirm identification. Once confirmed, the commissioner signs the form to certify that the form was completed in their presence.
- J. If the commissioner is not satisfied that the applicant has identified themselves as the voter in the precinct register, the commissioner may challenge the voter.
- K. An applicant who completes a **Voter Identification Affidavit (AV-34)** is subject to challenge before voting by a commissioner, watcher, or voter (*Section 7.21: Challenge of Voter at Polls*).
- L. Once the **Voter Identification Affidavit (AV-34)** is reviewed and compared to the precinct register and the commissioner is satisfied that the applicant has identified themselves as the voter in the precinct register and there is no **Challenge of Voter (CV-56) Form** (Figure 45) filed, the commissioner shall initial the precinct register opposite the voter's signature or mark, and then the voter shall be allowed to vote.
- M. Place the **Voter Identification Affidavit (AV-34)** in the **ROV (Registrar of Voters Envelope)**.

Figure 36: Voter Identification Affidavit (AV-34)



SECRETARY OF STATE
STATE OF LOUISIANA

VOTER IDENTIFICATION AFFIDAVIT

PARISH OF East Baton Rouge WARD/PRECINCT 02/16C

BEFORE ME, the undersigned commissioner, personally came and appeared the undersigned voter, who stated that they have not presented a Louisiana driver's license, a Louisiana special identification card, a United States military identification card that contains the applicant's name and picture, or other generally recognized picture identification card that contains the name and signature of the applicant; however, they have provided the following information as proof of their identity:

Voter's Name: John Doe
(please print)

Voter's Address: 113 Green Street Baton Rouge 70808
(street) (city) (zip code)

Voter's DOB: 04/25/84 Mother's Maiden Name: James
(please print) (please print)

Signature of Voter: X John Doe Date: 5/15/15

Signature of Commissioner: X Johnny Law Date: 5/15/15

Check box if applicant is unable to read/write or is otherwise unable to complete the affidavit due to a disability. (The applicant may receive assistance in completing the affidavit and the commissioner shall make a notation on the affidavit. The applicant may receive the assistance of any person of their choice, including a commissioner, except a candidate, commissioner-in-charge, the applicant's employer or employer's agent, or the applicant's union agent.)

DISPOSITION: PLACE IN PINK ROV ENVELOPE

Prepared and furnished by Secretary of State Approved by the Attorney General Voter Identification Affidavit (AV-34) (Rev. 1/20)

7.04: Election Day Etiquette

- A. When a voter with a disability comes to your precinct to vote, greet the voter and introduce yourself; then follow the guidelines below.
- B. If the voter has a visual impairment:
1. Do a quick double-check of the area for physical barriers that could present a problem.
 2. Do not take their arm to guide them without asking permission first.
 3. Describe what you are doing as you are doing it.
 4. Be specific with your instructions and say, for example, "take three steps forward to the table in front of you", rather than, "step over here."
 5. Do not feed or pet a guide dog without the owner's permission.
 6. If the voter with a visual impairment has brought a helper, remember to speak to the voter and not the helper.

C. If the voter has a hearing impairment:

1. You may point when explaining to the voter with a hearing impairment where to go.
2. When speaking to a voter with a hearing impairment, look directly at them and speak at an even, steady rate; this allows the voter the opportunity to read your lips if they are able to do so.
3. If the voter with a hearing impairment has brought an interpreter, remember to speak to the voter and not the interpreter.
4. Do not hesitate to write instructions if you have difficulty communicating.
5. If you have said something and you do not know if the voter understood you, ask if they understood, then rephrase the statement if necessary.
6. If the voter asks you to repeat yourself (“what did you say?”), do not respond with “nothing” or “never mind.” Simply repeat what you initially said.

D. If the voter has a cognitive disability (including dementia and other diseases of aging):

1. All people with cognitive disabilities (including dementia and other diseases of aging) have the right to vote unless that right has been specifically limited by a judge. It is not up to commissioners or election officials to decide if a person is competent to vote. If their name is in the precinct register, then they are eligible to vote.
2. People with cognitive disabilities may have a difficult time understanding you. You may have to repeat or rephrase to get your point across. With patience and a little extra effort, you can make sure their vote is cast.
3. Speak in plain, simple terms and in short sentences.
4. Give one instruction at a time, wait until that task is completed, and then go on to the next step.
5. Feel free to physically demonstrate how to do something without actually voting.
6. Do not raise your voice; just keep your voice steady and normal. The voter with a cognitive disability may not comprehend you clearly, but they can hear you.
7. Most importantly, remain patient.

E. If the voter has a speech disorder:

1. It can be as frustrating for the person speaking as it can be for you to understand.
2. Listen attentively and carefully.
3. Ask short questions that require short answers, preferably with a nod or shake of the head.
4. Writing might be a good alternative to speaking.
5. Do not interrupt a person with a speech disability.
6. Do not guess what the voter is trying to tell you; repeat what you understand, and wait for their response.

F. If the voter is in a wheelchair:

1. Do a quick double-check of the area for physical barriers that could present a problem.

2. Ask if the voter requires any assistance.
3. Always ask for permission before touching the wheelchair.
4. If the accessible entrance to the polling place is not the primary entrance, be sure there are signs and arrows indicating where the accessible entrance is located.

Note: Refer to Section 7.15: How to Assist a Voter with a Disability for instructions on lowering the voting machine to accommodate a wheelchair.

Note: The Department of Health and Hospitals (DHH) rules prohibit the assistance of health workers to voters in the casting of a ballot. The voter may receive assistance from others as noted in Section 7.13: Prohibited People for Assisting Voters.

7.05: Precinct Register and Poll List

- A. Any person who voted absentee or voted early shall NOT vote on election day. Check for special notations on the signature line for each voter. You will see the words “Voted absentee,” “Voted Early,” or a signature if the person has already voted.
- B. As the name of each voter is announced, two (2) commissioners keep duplicate Poll Lists (**PL-53 (Pink)** and **PL-53 (Gold)**), and each commissioner writes each voter’s name in their Poll List in consecutive number order, starting with number one (1). Print names clearly.
- C. All issues with a voting machine, a voter, a watcher, or any other incident involving the election should be recorded on the **Notation of Irregularities Form** by a commissioner.
- D. A commissioner who works the precinct register may also keep a Poll List, if necessary, so that each Poll List is handled by separate commissioners.
- E. If the applicant’s name is not found in the precinct register or a supplemental precinct register, refer to *Section 7.09: Omissions in Precinct Register*.
- F. If “Address Confirmation Req.” appears on the signature line beside the printed name, the applicant is an inactive voter and must complete an **Address Confirmation Card-Election Day (ACC) Form** (Figure 37) before voting.
- G. An inactive voter is a person whose residential address was unable to be verified by the registrar of voters. The applicant’s eligibility to vote in the election is based on the information given by the applicant after the applicant has completed the **Address Confirmation Card-Election Day (ACC) Form**.

7.06: Address Confirmation Card - Election Day (ACC) Form

- A. In Section 1 of the **Address Confirmation Card-Election Day (ACC) Form**, the commissioner prints the voter's registration number, name, address, and date of birth found in the precinct register and then gives the form to the voter to complete and sign.
- B. Voter completes Section 2 of the **Address Confirmation Card-Election Day (ACC) Form**.
 - 1. If the applicant affirms that their residence address is correct in Box 1 of Section 2, the applicant may vote. The applicant may provide a mailing address, which may be a P.O. Box, and the applicant may indicate if there is no mail delivery to the residential address.
 - 2. If the applicant affirms that they still reside within the parish in Box 2 of Section 2, but their residential address is not correct, the applicant may vote upon providing a new residential address. A mailing address, which may be a P.O. Box, may also be added, and the applicant may indicate if there is no mail delivery to the residential address.
 - 3. If the applicant affirms in Box 3 of Section 2 that they no longer live in the parish, but it has been less than three (3) months since they moved, the applicant may vote by completing the form.
- C. If the applicant has moved to another parish or state and cannot affirm that they have moved less than three (3) months before the election, they cannot vote on the voting machine. The applicant should be given a voter registration application to complete to be eligible to vote in their new parish for the next election.
- D. If there are any questions, have the applicant contact the Registrar of Voters Office. Please refer to Section 3 of the **Address Confirmation Card-Election Day (ACC) Form** for voter's additional information and rights.
- E. In a **FEDERAL ELECTION**, if the voter has moved out of the parish more than three (3) months before the election, they may vote a provisional ballot in accordance with the process outlined in *Part 10: Provisional Voting (Federal Elections Only)*.
- F. If the applicant has completed the **Address Confirmation Card-Election Day (ACC) Form**, one of the commissioners shall announce the applicant's name again and shall place the **Address Confirmation Card-Election Day (ACC) Form** in the **ROV (Registrar of Voters Envelope)**.

Figure 37: Address Confirmation Card-Election Day (ACC) Form

ADDRESS CONFIRMATION CARD - ELECTION DAY

STATE OF LOUISIANA

SECTION 1: COMMISSIONER, PRINT INFORMATION FROM THE PRECINCT REGISTER.

Voter Reg. #: 00000000 Voter Name: John Doe DOB: 01/01/1981

Residence Address: 123 Green St. Baton Rouge 70808
(Street) (City) (Zip Code)

SECTION 2: VOTER, YOU MAY VOTE BY AFFIRMING YOUR RESIDENCE ADDRESS. PLEASE CHECK ONLY ONE (1) BOX THAT APPLIES TO YOU.

1. I affirm that my residence address printed above is correct.
 Check here if no mail delivery to your residence address.

Add a Mailing Address: P.O Box 187 Baton Rouge 70808
(Street/P.O. Box) (City) (Zip Code)

2. I affirm that I still reside within the parish, but my residence address printed above is not correct.

New Residence Address: _____
(Street) (City) (Zip Code)

Check here if no mail delivery to your residence address.

Add a Mailing Address: _____
(Street/P.O. Box) (City) (Zip Code)

3. I affirm that I no longer live within the parish, but have moved within the last three (3) months and I request to have my voter registration transferred to my new residential address.

New Residence Address: _____
(Street) (City) (Zip Code)

Note: If you are not able to affirm that you have moved within the last three (3) months, you shall not be permitted to vote today. Do not complete this form, but complete a voter registration application and return it to the commissioner for processing by the registrar of voters. You must register in your new parish 20 days prior to an election if registering through our GeauxVote Online Registration System or 30 days prior to an election if registering in person or by mail registration in order to vote in the next election.

SECTION 3: VOTER, PLEASE SIGN OR MAKE YOUR MARK.

Your signature below allows your registration address to be updated and/or transferred to the correct parish by the registrar of voters.

John Doe 1/15/17
(Voter's Signature or Mark) (Date)

Voter's Contact Phone Number: 225-555-9798
(For Official Use Only)

If you sign with a mark, two witnesses to your mark are required by law and must sign here:

Witness #1: _____ Witness #2: _____
(Signature) (Signature)

Voter's Information and Rights

IMPORTANT: Your registration status may be inactive until your registration address is confirmed. YOU MAY VOTE but will be required to confirm your address by completing and returning this Address Confirmation Card-Election Day. When completing this card, please note that state law requires you to register where you reside and if you file a homestead exemption on a residence, you are required to register and vote where you claim a homestead exemption. **Displaced voters:** A person who has been displaced from their residence by a state of emergency is not considered to have vacated their residence and is considered a resident of the state and parish where they are registered to vote unless (1) they change their voter registration address or (2) they claim a homestead exemption on a different residence. To maintain your registration address at your pre-emergency address, list your residence address at your pre-emergency address and provide a mailing address where you currently reside and receive mail.

WARNING: ANY FALSE STATEMENT MADE ON THIS FORM CONSTITUTES AN ELECTION OFFENSE PUNISHABLE BY LAW.

DISPOSITION: PLACE COMPLETED FORM IN ROV ENVELOPE

ACC-ELECTION DAY Prepared and Furnished by Secretary of State (Rev. 01/18)

Commissioner Completes Section 1

Voter Completes Section 2

Voter Signs Section 3

7.07: Signature of the Applicant in Precinct Register

- A. If the applicant is able to sign their name, they shall sign their handwritten signature in ink in the field provided in the precinct register.
- B. The applicant's signature shall be compared to their signature on either the photo ID or the **Voter Identification Affidavit (AV-34)**.
- C. If the applicant is unable to sign their name, they shall make their mark in ink on the signature line in the precinct register.

7.08: Error in Precinct Register or Voter's Record

- A. A **Voter Registration Application (LA-VRA)** is used when a person's name or voter record is incorrect in the precinct register.
- B. If a voter's name is misspelled or if their voter record is incorrect on the precinct register, and the record has been verified to be the voter's, the commissioner gives the voter a **Voter Registration Application (LA-VRA)** to complete and allows the voter to sign the precinct register.
- C. The completed **Voter Registration Application (LA-VRA)** is placed in the **ROV (Registrar of Voters Envelope)** for delivery to the registrar of voters.

7.09: Omissions in Precinct Register

- A. A **Precinct Register Correction (PRC) Form** (*Figure 38*) is used when a person's name is omitted from the precinct register.
- B. A person may be authorized to vote when their name does not appear in the precinct register or supplemental precinct register. The commissioner must
 1. call and receive authorization from either the Registrar of Voters Office, or
 2. call and receive authorization from the Secretary of State's Office (1-800-883-2805).
- C. A commissioner may look up a person's registration and precinct information on the secretary of state's GeauxVote mobile app (<https://voterportal.sos.la.gov/MobileLanding.aspx>) to assist a voter in finding their correct precinct. The app is free in the app store as GeauxVote. **IMPORTANT:** The GeauxVote mobile app may **not** be used to authorize a person to vote because they may have already voted early or absentee-by-mail. It may only be used to direct a voter to their correct precinct.

Figure 38: Precinct Register Correction (PRC) Form

PRECINCT REGISTER CORRECTION - PRC

SECTION 1: VOTER AFFIDAVIT

On this 25th day of January, 2015, personally came and appeared
(day) (month) (year)

John Doe, Sr.
(print voter's name)

who stated that they are a qualified registered voter in the Parish of East Baton Rouge

Ward 22 Precinct 1 Registration # 5555555555, and that
(optional information)
 their name was omitted from the precinct register.

John Doe 123 Green Street, Baton Rouge, LA 70808
(signature of voter) (residence address of voter)

P.O. Box 123, Baton Rouge, LA 70808
(mailing address of voter, if different from above)

SECTION 2: COMMISSIONER AUTHORIZATION

The commissioner contacted the Registrar of Voter's Office and/or the Secretary of State's Office and received authorization to allow the above listed person to vote and provided the commissioner with the valid lockout/button# for the voter.

Authorization was granted by Rose Law Lockout/Button # is 1
(name/office) (lockout/button#)

Henry Blue
(signature of commissioner or commissioner-in-charge)

DISPOSITION: PLACE IN PINK ROV ENVELOPE (REGISTRAR OF VOTERS ENVELOPE).

Prepared and Furnished by the Secretary of State PRC (Rev 5/21)

D. A **Precinct Register Correction (PRC) Form** must be completed by a commissioner and signed by the voter in the following manner:

1. The commissioner completes the date, voter's name, parish, ward/precinct, and registration number fields (if provided by election official or election document) in Section 1.
2. The voter signs and provides their address in Section 1.
3. The commissioner completes Section 2 of the form by documenting the authorization given to allow the person to vote, noting the lockout/button number for the voter, and then signs the form.

E. Once the **Precinct Register Correction (PRC) Form** is complete:

1. The commissioner must print the voter's name on the blank precinct register page behind the **Precinct Register Correction Affidavit Tab**.
2. The voter must sign in the appropriate field.
3. The commissioner must initial the voter's signature in the appropriate field.
4. The commissioner enters the voter's name on both poll lists (**PL-53 (Pink)** and **PL-53 (Gold)**).

F. Once the voter has been added to the precinct register page behind the **Precinct Register Correction Affidavit Tab**, the commissioner places the **Precinct Register Correction (PRC) Form** in the **ROV (Registrar of Voters Envelope)**.

G. Provisional Voting for **FEDERAL ELECTIONS**:

If a voter's name does not appear on the precinct register or supplemental precinct register and the voter has NOT been authorized to vote through the **Precinct Register Correction (PRC) Form** process provided in this section, the commissioner may allow them to vote by paper provisional ballot in accordance with *Part 10: Provisional Voting (Federal Elections Only)*. If the voter believes that they were mistakenly labeled as "Early Voted" or "Voted absentee" on the precinct register, contact the registrar of voters for further instruction.

7.10: Assistance to Voters

- A. **IMPORTANT:** Any voter who has a visible physical disability or who presents a current mobility-impaired identification card bearing the photograph of the voter and the international symbol of accessibility issued by the Louisiana Department of Public Safety and Corrections, along with the person assisting them in voting, **MUST BE ALLOWED TO GO TO THE FRONT OF THE LINE** to cast a ballot.

7.11: Louisiana Laws Regarding Assistance

- A. Louisiana's Election Code specifies that a voter shall NOT receive assistance in voting unless they are unable to read or unable to vote without assistance because of a physical disability, including being visually impaired.
- B. The law provides specific rules in assisting voters with disabilities, including visual impairment; these rules **MUST BE** followed strictly during an election.
- C. Be sure you understand these guidelines before assisting someone directly in voting.
- D. If a polling place to which a voter is assigned is inaccessible to them by reason of a physical disability, the voter may cast their vote at the nearest polling place which is accessible if the polling place has the same ballot. The registrar of voters will inform you and/or the clerk of court if the voter has authorization to cast their vote at another precinct in this situation.

7.12: Disability Documentation

- A. Voters with disabilities can either register to vote indicating that they need assistance in voting; or, after registering and becoming disabled, they can complete a new **Voter Registration Application (LA-VRA)** with this change, or they may file a statement outlining their need for voting assistance with the registrar of voters. If the voter notifies the registrar of voters that they need assistance in voting in a timely manner before the election, the precinct register will indicate that the voter is entitled to receive assistance in voting. The second to last column on the precinct register with the heading "ASST" is where you look for an indication of whether or not the voter is entitled to assistance in voting.
- B. The precinct register (*Figure 40*) will be marked with a "Y" for "Yes" in the "ASST" column if the voter is registered as needing assistance in voting.
- C. If there is no "Y" in the "ASST" column on the precinct register and the voter requests assistance because they are **unable to read, they must be allowed to have assistance**. The voter may receive assistance from anyone they choose, except those prohibited from assisting a voter listed in *Section 7.13: Prohibited People for Assisting Voters*, or they may use the **AUDIO UNIT**.

- D. A voter who is physically disabled is entitled to assistance without having previously registered for assistance if, on election day, the voter completes and signs a **Voter Assistance Form (VAF)** form (Figure 39).
- E. If a voter presents the commissioner with a copy of current documentation showing eligibility for social security disability benefits, veteran's disability benefits, paratransit services, benefits from the office for citizens with developmental disabilities, or benefits from Louisiana Rehabilitation Services, the voter may receive assistance even if the precinct register does not indicate "Y" in the "ASST" column.
- F. The commissioner must retain the **Voter Assistance Form (VAF)** form and any **Voter Registration Applications (LA-VRA)**, copies of disability documentation, or letters from a medical doctor, optometrist, physician assistant or nurse practitioner certifying the disability and place them in the **ROV (Registrar of Voters Envelope)**.

Figure 39: Voter Assistance Form (VAF)

VOTER ASSISTANCE FORM			
STATE OF LOUISIANA			
PARISH OF <u>East Baton Rouge</u>	WARD/PRECINCT <u>15/28</u>	VOTER REGISTRATION # <u>18256456</u>	
SECTION 1: VOTER'S INFORMATION:			
I, the undersigned voter, hereby attest that I have a physical disability and require assistance in voting.			
Voter's Name: <u>John Doe</u> <small style="text-align: center;">(please print)</small>			
Voter's Address: <u>876 North Blue St.</u> <u>Baton Rouge</u> <u>70819</u> <small style="text-align: center;">(street) (city) (zip code)</small>			
Voter's DOB: <u>April 5, 1986</u> La. DL/ID # or last four of SSN: <u>000065444</u> <small style="text-align: center;">(mm/dd/yyyy)</small>			
Do you want to change your registration to indicate that you require assistance in voting? <input checked="" type="checkbox"/> Yes <input type="checkbox"/> No			
Signature of Voter: <u>John Doe</u> Date: <u>10/14/2017</u>			
SECTION 2: COMMISSIONER SIGNATURE:			
Signature of Commissioner: <u>Martha Stewart</u> Date: <u>10/14/2017</u>			
Print Commissioner Name: <u>Martha Stewart</u>			
DISPOSITION: PLACE COMPLETED FORM IN REGISTRAR OF VOTERS (ROV) ENVELOPE			
<small>Prepared and furnished by Secretary of State</small>		<small>Approved by the Attorney General</small>	
<small>Voter Assistance Form (VAF) (Rev. 06/19)</small>			

Figure 40: Precinct Register Diagram

Example Precinct Register

A voter cannot vote if the signature column is either signed or is printed/stamped "Voted Absentee" or "Voted Early"

This column is used for identification purposes when a voter does not have a photo ID and is an affidavit voter. Voter MUST complete an AV-34.

The "ASST" column notes if the voter is eligible to receive assistance. It will either be blank or have a "Y" for yes in it.

Dist/Ward: 00	Precinct: 000	PctBallot: 0	Election Date:	Parish:	Page: 1					
Voter Number	Name of Voter	Signature	Comm Initials	Barcode	Address (DOB) Mother's Maiden Name	Lockout Districts	S R E S E X P	A S T Y	P R T Y	DEM
8484888	HOFFMAN	VOTED ABSENTEE	ROV	[Barcode: 8003147]	Johns	1 - BUTTON 1	F	W	Y	DEM
6546516	HOLDER	ADDRESS CONFIRMATION REQ		[Barcode: 8032933]	Jones	3 - BUTTON 3	M	B		NOPTY
5116465	HOLLAND	VOTED EARLY	ROV	[Barcode: 1961438]	Lewis	7 - BUTTON 7	F	O		NOPTY
5165161	HOLLINGSHEAD	<i>Hollingshead</i>	RP	[Barcode: 1880950]	Henry	7 - BUTTON 7	M	W		NOPTY
5668541	HOLMES			[Barcode: 7094385]	Snow	7 - BUTTON 7	F	B		DEM

Voter MUST complete an "Address Confirmation Card (ACC)" form before voting if "Address Confirmation Req." is listed by their name.

The "Lockout District" column has a number to indicate the correct lockout on the Operator Panel.

7.13: Prohibited People for Assisting Voters

- A. A voter is entitled to assistance in voting from any person of their choice, including a commissioner; however, there are exceptions as follows:
1. No candidate in any election may assist a voter.
 2. No commissioner-in-charge may assist a voter.
 3. No employer or employer’s agent may assist an employee in voting.
 4. No union agent may assist a union member in voting.

Note: By rule, the Department of Health and Hospitals (DHH) prohibits staff from assisting residents of state-operated facilities for mentally disabled/developmentally disabled persons.

7.14: Documenting Voter Assistance

- A. Before a voter receives assistance, the commissioner must check if the person in the precinct is listed as having a “Y” for “Yes” under the “ASST” column on the precinct register. If yes, the voter or commissioner prints the voter’s and assistant’s names (including a commissioner if providing assistance) on **Assistance to Voters Page** (Figure 41), behind the tab, in the back of the precinct register. The assistant (including a commissioner providing assistance) must sign their name next to their printed name before assisting the voter.
- B. If there is no “Y” in the “ASST” column in the precinct register, but the voter is authorized by the commissioner to receive assistance either because the voter is unable to read or has a physical disability with supporting documentation discussed in *Section 7.12 Disability Documentation*, the commissioner checks the box indicating that there is no “Y” in the “ASST” column, but the voter was allowed assistance.

Figure 41: Assistance to Voters Page

Assistance to Voters			
Ward:	Precinct:	PctBallot:	Election Date:
			Parish:
			Page:
No 'Y' in ASST Column for Voter	Print Voter's Name	Print Assistant's Name	Signature of Assistant
1 <input type="checkbox"/>	Jon Williams	Glenn Helpsalot	<i>Glenn Helpsalot</i>
2 <input type="checkbox"/>	James Jones	Henry White	<i>Henry White</i>
3 <input checked="" type="checkbox"/>	Saul Rosenberg	Sammy Watts	<i>Sammy Watts</i>
-	Check ALL	Update	

7.15: How to Assist a Voter with a Disability

- A. Voting rules for people that need assistance because of a disability:
1. The person assisting the voter enters the voting booth with the voter and assists the voter in any way necessary for the voter to cast a ballot.
 2. No other person is allowed in the voting booth (except a minor accompanying a parent or legal guardian).
 3. Whoever provides assistance is bound by law to keep what happens in the voting booth a secret; never to reveal or discuss how the voter with a disability voted.
 4. Voters receiving assistance are allowed twenty (20) minutes to cast their ballot.
- B. A voter with a visual impairment may request assistance or use an audio ballot. If the voter chooses the audio ballot, the commissioner is responsible for demonstrating how it works and assisting the voter in casting their ballot, if such assistance is requested.
- C. The voting machine can accommodate most voters in wheelchairs while in its upright voting position. If needed and upon request, a minor adjustment can be made to lower the voting machine before allowing the voter to approach the voting machine:
1. Ask the voter if they would like the voting machine to be lowered.
 2. If they say yes, lower the display to the lowest position to accommodate a voter in a wheelchair, and position the voting machine in the room to give the voter the greatest possible privacy in voting.
- D. Procedure to lower the voting machine for a disabled person:
1. Go to the rear of the voting machine.
 2. Pull the **maroon latch** (*Figure 42*) to tilt the display forward to the desired angle (two notches forward is known as vertical position for seated voters).

Figure 42: Maroon Latch on Voting Machine



- E. The **Supply/Lead Voting Machine** front left panel in every precinct may have a clear plastic pocket with a Full Page Magnifier and a Braille Audio Voting Keypad Guide for use by any voter who may need these tools.

Note: If so, please replace in the clear pocket in the front left panel of the voting machine at the end of voting.

- F. In a **FEDERAL ELECTION**, if a voter appears to have a visual impairment, commissioners shall offer the voter the Braille Booklet containing the Instructions to Voters found in the **Braille Booklet Envelope (BBE)** in the **Green Canvas Bag**. For all elections, a voter with a visual impairment may use the **Audio Unit**.

7.16: Audio Voting

- A. The audio ballot is available for any voter and is not limited to only the disabled or those needing assistance. If the voter elects to use an audio ballot, the commissioner shall assist the voter with the headset and instruct the voter and the person selected to assist the voter on the use of the audio ballot.
- B. The commissioner shall offer the voter and the person selected to assist the voter the “Guide to Using the Audio Voting Keypad (Audio Voting Keypad Quick Chart)” or the Braille version.
- C. The audio voting accessory components are shown in Figure 26.
- D. The audio voter is allowed twenty (20) minutes to cast their ballot.
- E. The audio unit should be on the back of the voting machine waiting for use. It should already be connected. If not in the voting machine, contact the clerk of court or voting machine warehouse technicians for assistance.
- F. See *Section 7.20: Audio Voter* for specific instructions in setting up the voting machine for an audio voter.

7.17: Allowing Voters to Vote

- A. The commissioners shall enter the name of every person who votes at the polling place on each poll list (**PL-53 (Pink)** and **PL-53 (Gold)**) (*Figure 43*). **PLEASE PRINT THE NAME CLEARLY, AND DO NOT WRITE IN CURSIVE!**

Figure 43: Poll List

NO.	PLEASE PRINT NAME OF VOTER	NO.	PLEASE PRINT NAME OF VOTER
1.		31	
2.		32	
3		33	
4		34	
5		35	

- B. A commissioner shall initial the precinct register opposite the voter’s signature or mark.
- C. A commissioner may need to instruct a voter on how to use the voting machine and can direct them to the **Election Day Louisiana Voters’ Bill of Rights and Voting Information Poster (VBR-IP)**, which explains how to cast a ballot. Commissioners may instruct all voters on the general instructions of the voting machine as follows:
1. The voter should enter through the curtain when it is their turn to vote.
 2. The voter should look for the **green header lights** by the titles of office (not the box where they make a selection for a candidate). These are offices the voter may vote on. If the voter does **not** see an office title light up that they believe they are eligible to vote on, they must inform a commissioner before casting their ballot to see if there is a mistake that can be corrected. The commissioner should check to make sure they activated the machine with the correct button number for the voter.
 3. To vote for a candidate, a voter must press the **white box** to the right of the candidate’s name or next to the **YES** or **NO** for a proposition or next to the **FOR** or **Against** for a Recall election. A **green “X”** will light up to the left of the box, like this: **X** , and the **green header light** for the office or proposition will turn off.
 4. To change a vote, the voter must deselect the candidate that they voted for by pressing the **white box** again by the candidate or proposition. The **green “X”** will disappear and the **green header light** will light back up. Next, they must press the **white box** by the new candidate or proposition and the **green “X”** will appear by that choice.
 5. After the voter has made ALL SELECTIONS, then they **MUST** press the **orange CAST VOTE button**. The **orange CAST VOTE button** is in the bottom right-hand corner of the voting machine.
 6. The voting machine will make a unique electronic beeping sound when the vote has been recorded.

Important: *It is important to remind the voter to make all selections before casting their ballot because once they press the **orange CAST VOTE button**, they have voted and may not vote again.*

7.18: Precincts without a Lockout

- A. For precincts WITHOUT A LOCKOUT, meaning all voters in the precinct may vote on every candidate race and proposition on the ballot, there will be no button number in the “Lockout Districts” column in the precinct register. The commissioner simply needs to activate the voting machine for each voter as follows:
1. Press the **green ACTIVATE button** on the operator panel (*Figure 44*).
 2. The voting machine is activated and responds as follows:
 - a. The operator panel will make a sound.
 - b. The light next to the ACTIVATE button will light up.
 - c. The display on the operator panel will read, **“VOTER ACTIVE.”**
 - d. The booth light in the voting machine will turn on.

Figure 44: Operator Panel

The diagram shows the AVC Advantage Operator Panel. At the top, it displays 'AVC Advantage' and status indicators for 'AC POWER' and 'BATTERY LOW'. A central screen shows 'VOTER INACTIVE' and '972 POLLS OPEN'. Below the screen is a keypad with buttons numbered 1 through 12. A 'TEST' button is on the left and an 'ACTIVATE' button is on the right. A blue box labeled 'Lockout Button Numbers 1-12' has yellow arrows pointing to buttons 1, 2, 3, 4, 5, 6, 7, 8, 9, 10, 11, and 12. A green box labeled 'Green ACTIVATE Button' has a green arrow pointing to the ACTIVATE button. Below the keypad is a data table with columns for Voter Number, Name of Voter, Signature, Comm Initials, Barcode, Address (DOB|Mother's Maiden Name), Lockout Districts, and Party. The table contains five rows of voter data. At the bottom of the table are 'Check ALL' and 'Update' buttons with barcodes.

Voter Number	Name of Voter	Signature	Comm Initials	Barcode	Address (DOB Mother's Maiden Name)	Lockout Districts	Party
1	ABOAGYE	→		[Barcode]	Johns	1 - BUTTON 1	DEM
2	ABRAHAMS	→		[Barcode]	Jones	3 - BUTTON 3	DEM
3	ADAMS	→		[Barcode]	Lewis	7 - BUTTON 7	DEM
4	ADAMS	→		[Barcode]	Henry	7 - BUTTON 7	REP
5	ADAMS	→		[Barcode]	Snow	7 - BUTTON 7	NOPTY

7.19: Precincts with a Lockout

A. For precincts WITH A LOCKOUT, meaning that not all voters may vote on every candidate race or proposition on the ballot, there will be a button number in the “Lockout Districts” column for each voter. The commissioner needs to look at the button number for each voter in the precinct register and activate the voting machine as follows:

1. On the operator panel, press the lockout button number for the voter listed in the precinct register (*Figure 44*).
2. Press the **green ACTIVATE button** on the operator panel.
3. The voting machine responds as follows:
 - a. The operator panel will make a sound.
 - b. The light next to the **ACTIVATE** button will light up.
 - c. The display screen on the operator panel will show which button number was selected.
 - d. The booth light in the voting machine will turn on.

Important: *If a commissioner selects the incorrect lockout button number for the voter and has not pressed the **green ACTIVATE button**, the commissioner can correct it by simply pressing the correct button number.*

Tip: If the **ACTIVATE button** has already been pressed, call the clerk of court or voting machine technician for instructions.

B. The commissioner can confirm that the voter has completed voting by being aware of the following four (4) things:

1. **Listen** – the voting machine will make a unique electronic beeping sound after the **orange CAST VOTE button** has been pressed.
2. **Look** – the light next to the **ACTIVATE** button will turn off.
3. **Look** – the display on the Operator panel will read “VOTER INACTIVE” “POLLS OPEN” and the public and protective counters will increase by one (1).
4. **Look** – the booth light in the voting machine will turn off.

C. If the voter leaves the booth (fled voter) without pressing the **orange CAST VOTE button**, ask the voter to return to the booth in order to complete voting by pressing the **orange CAST VOTE button**, if the voter is still in the polling place.

Note: *This may be a common mistake of the voter, so it is very important to listen and look for the signals listed above.*

D. If the voter leaves the booth without pressing the **orange CAST VOTE button** and has left the polling place, the commissioner, while observed by at least one other commissioner and without changing any selection made by the voter, shall reach their hand behind the curtain (without going into the voting machine) and press the **orange CAST VOTE button**.

1. If the four signals listed above occur, the voting machine is ready for the next voter; and
2. If these signals do not occur, it means the previous voter left the voting machine without making any selections and it is important that the commissioner make a notation on the **Notations of Irregularities Form** because the poll lists will have one (1) more voter than your public counter on that voting machine.

Tip: The voting machine is activated so if there is NO LOCKOUT, the next voter in line may vote on the machine. However, if there is a LOCKOUT on the machine, call the clerk of court or voting machine technician for instructions.

E. Other general responsibilities of commissioners in allowing voters to vote during an election:

1. The commissioners shall not allow more voters to approach the voting machines than there are vacant voting machines available.
2. The commissioners shall not allow more than one person to enter a voting machine at a time, except when a voter is entitled to assistance; however, a minor may accompany their parent or legal guardian. Recommend that the child stay to the left of the parent so that they do not accidentally press the **orange CAST VOTE button** before the parent has made all of their selections and completed voting.
3. A voter is allowed six (6) minutes to vote, unless they are using the audio ballot or needing assistance, in which case they may have a maximum of twenty (20) minutes. Encourage voters to review the sample of the official ballot posted at the precinct or on their smartphone in the GeauxVote app, which can be marked online and used in the voting booth. If the ballot is lengthy or if it contains complex propositions or constitutional amendments, the commissioners may allocate additional time in an equitable manner.
4. A voter shall promptly leave the polling place after voting and shall not reenter a voting machine.
5. The commissioners shall keep two (2) duplicate poll lists, a **PL-53 (Pink)** and **PL-53 (Gold)**, for each precinct, numbered consecutively from one to the end.
6. The commissioners should periodically check the public counter numbers (lower right-hand number) on the operator panel of the voting machines and the number of voters entered on the Poll Lists. If there is a discrepancy between the total number of voters who have voted on all of the voting machines and the number of voters listed in the Poll Lists, make a note on the **Notation of Irregularities Form** describing the time and details of what happened.
7. In a Federal Election, provisional voters' names, if any, shall be entered on page 29 of the Poll Lists (**PL-53 (Pink)** and **PL-53 (Gold)**), beginning with number 1681
(Ref. Part 10: Provisional Voting (Federal Election Only)).

7.20: Audio Voter

- A. Call the voting machine technician for assistance with using the audio voting keypad, if needed.
- B. Give the audio voting keypad and headset to the voter before they enter the voting machine. A voter may use their own headset if it has a universal plug. The voter may need to have the keypad strapped to their arm or wheelchair, but always ASK THE VOTER their preference first. If the voter uses a sip and puff mechanism, it can be inserted into the bottom right hand corner of the keypad.
- C. For precincts WITHOUT A LOCKOUT, there will be no button number in the “Lockout Districts” column in the precinct register. To activate the voting machine for an AUDIO VOTER:
 1. Press the **yellow TEST button** on the operator panel and the display screen reads “RETURN TO VOTER INACTIVE.”
 2. Press the **yellow TEST button** again on the operator panel and the display screen reads “ENABLE AUDIO VOTING.”
 3. Press the **green ACTIVATE button** on the operator panel and the display screen reads “AUDIO VOTING ENABLED” and then “VOTER INACTIVE AUDIO MODE.”
 4. Finally, press the **green ACTIVATE button** again on the operator panel.

Note: In summary, to activate the voting machine for an audio voter without a lockout, press **yellow > yellow > green > green** before allowing the audio voter to vote.

- D. For precincts WITH A LOCKOUT, there will be a button number in the “Lockout Districts” column for each voter. The commissioner needs to look at the button number for each voter in the precinct register and activate the voting machine for an AUDIO VOTER:
 1. Press the **yellow TEST button** on the operator panel and the display screen reads “RETURN TO VOTER INACTIVE.”
 2. Press the **yellow TEST button** again on the operator panel and the display screen reads “ENABLE AUDIO VOTING.”
 3. Press the **green ACTIVATE button** on the operator panel and the display screen reads “AUDIO VOTING ENABLED” and then “VOTER INACTIVE AUDIO MODE.”
 4. Press the lockout button number for the voter listed in the precinct register on the operator panel.
 5. Finally, press the **green ACTIVATE button** again on the operator panel.

Note: In summary, to activate the voting machine for an audio voter with a lockout, press **yellow > yellow > green > lockout button number > green** before allowing the audio voter to vote.

7.21: Challenge of Voter at Polls

- A. A commissioner, watcher, or qualified voter may challenge a person applying to vote on any of the following grounds:
1. The applicant/voter is not qualified to vote in the election.
 2. The applicant/voter is not qualified to vote in the precinct.
 3. The applicant/voter is not the person whose name is on the precinct register.
- B. Additionally, all voters who complete a **Voter Identification Affidavit (AV-34)** are subject to challenge before voting with a **Challenge of Voter (CV-56) Form** (Figure 45).

Figure 45: Challenge of Voter (CV-56) Form

CHALLENGE OF VOTER -- AT POLLING PLACE

The undersigned hereby challenges the right of the applicant/voter John Doe
(name of person challenged/voter)

to vote in **Ward** 1, **Precinct** 15, **Parish of** East Baton Rouge

on the grounds that the applicant/voter: is not qualified to vote in the election;
 is not qualified to vote in the precinct; or
 is not the person whose name is shown on the precinct register.

This challenge is made and entered in accordance with La. R.S. 18:565.

Signed this 23rd day of June, 2018

Jon Williams 123 Blue Street
(signature of challenger) (address of challenger)

DETERMINATION OF CHALLENGE The challenge is valid. The challenge is invalid.

Jane Doe John Dear Anne Doe
(commissioner-in-charge) (commissioner) (commissioner)

Ben Doe Keny Smith Doe
(commissioner) (commissioner)

INSTRUCTIONS TO COMMISSIONERS: The commissioners shall determine the validity of the challenge. If they determine by majority vote that the challenge is valid, the applicant/voter shall not be permitted to vote. If they determine by majority vote that the applicant/voter has moved within the parish or has moved outside the parish within the last three months, the applicant/voter shall be permitted to vote upon completing an Address Confirmation Card. If the majority determines the challenge is invalid, the applicant/voter shall be permitted to vote.

DISPOSITION: Place pink original in the ROV (Registrar of Voters Envelope), white copy in the Clerk of Court's Zipper Bag, and give the green copy to the voter.

Prepared and Furnished by Secretary of State CV-56 (Rev. 8/19)

7.22: Disposition of the Challenge

- A. If a challenge is made, the commissioners must determine by a majority vote whether the challenge is valid or invalid. Regardless of the outcome, the **Challenge of Voter (CV-56) Form** must be filled out. If the challenge is INVALID, the applicant must be permitted to vote.
- B. If the commissioners determine by majority vote that the challenge is VALID, the applicant shall NOT be permitted to vote; however, if it is a federal election, the applicant may vote a provisional ballot. (See Part 10 to determine if a voter is qualified to vote provisionally.)
- C. If the valid challenge is based on change of residence and the applicant has moved within the parish or has moved outside the parish within the last three months, the voter shall be allowed to vote upon completing an **Address Confirmation Card-Election Day (ACC)** (Figure 37).

- D. The completed **Challenge of Voter (CV-56) Form** must be handled by the commissioner in the following manner:
1. The completed **pink** original copy of the **Challenge of Voter (CV-56) Form** is placed in the **ROV (Registrar of Voters Envelope)**.
 2. The white duplicate copy of the **Challenge of Voter (CV-56) Form** is placed in the Clerk's Clear Plastic Zipper Bag.
 3. The **green** copy of the **Challenge of Voter (CV-56) Form** is given to the applicant (person being challenged).
- E. The commissioners must document the challenge to voter event and the outcome on the **Notation of Irregularities Form**.

Part 8: Closing the Polling Place

*TIP: Use the **Commissioner Close Polls Checklist** at the end of this pamphlet to assist you in completing all steps.*

8.01: When to Close the Polling Place

- A. At 8 p.m., announce that the polls are closed and that the election results will be posted outside or on glass at the polling place for public viewing from the outside of the polling place.
- B. Never close the polls or remove any election signage before 8 p.m.
- C. If there are voters in line, move them inside if there is sufficient room at the polling place.
- D. Lock the door to the polling place, or place a commissioner or law enforcement officer, if available, at the end of the line at 8 p.m.
- E. Allow all voters in line at 8 p.m., and any eligible commissioners who are on the precinct register and who have not voted, to vote.

8.02: Extended Poll Hours Voting (Federal Elections)

- A. If the commissioners are notified by the clerk of court or the secretary of state that the poll hours in an election for federal office are extended by court order, anyone who votes during the extension shall vote by paper provisional ballot for federal offices only. The procedures set forth in *Section 10.05: Election Day Provisional Voting Procedures* shall be followed for provisional voting.

IMPORTANT: The commissioners shall write “**Extended Poll Hours**” next to each provisional voter’s name in the Poll Lists (**PL-53 (Pink)** and **PL-53 (Gold)**) and check “Court Ordered Extended Polling Hours” under the “Select Type(s) of Provisional” section of the **Provisional Ballot Affidavit Envelope (AFF-PB)** for each voted provisional ballot.

8.03: Procedures after Polling Place Has Been Closed

- A. Follow these steps once the polling place has closed:
 - 1. Complete and certify the correctness of the two (2) duplicate Poll Lists (**PL-53 (Pink)** and **PL-53 (Gold)**) on the back covers and sign.

***Note:** If there are any discrepancies between the total of all the public counters and the Poll Lists, make a notation of the reason on the **Notation of Irregularities Form**.*
 - 2. Secure the voting machines against further voting:
 - a. Remove the voting machine keys from the **B-02 Key Envelope**.
 - b. Unlock and open the back door with the **yellow-capped key**.
 - c. Close the polls by inserting the **silver key** into the “**POLLS OPEN/POLLS CLOSED**” slot and turning the **silver key clockwise** to the “**CLOSED**” position (*Figure 46*).

CAUTION: DO NOT TURN THE KEY BACK TO OPEN.

CAUTION: DO NOT TURN THE KEY BACK TO OPEN.

Figure 46: Closing Polls

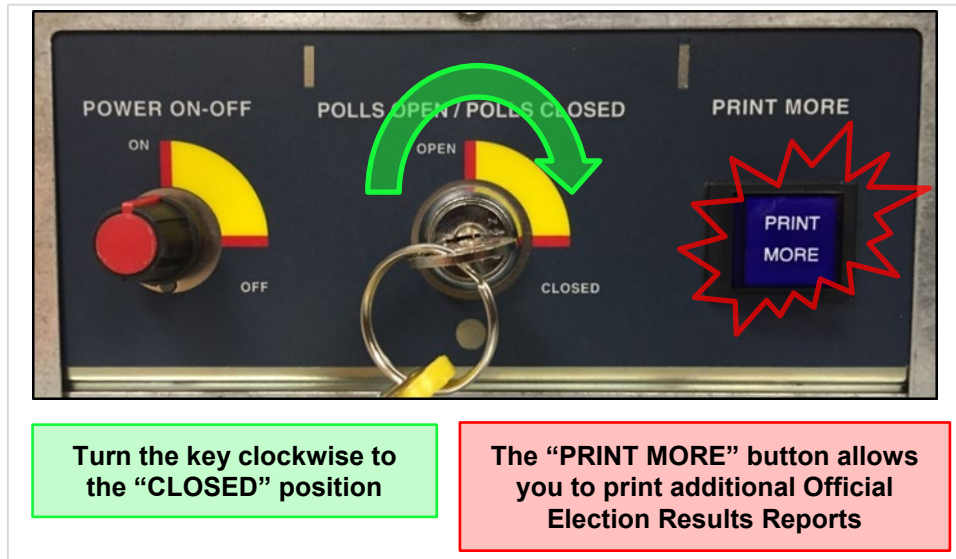

3. Once the key is turned to the closed position, **immediately remove key**. The printer will begin printing four (4) **Official Election Results Reports**.

IMPORTANT: Do not remove the **Blue Results/Audio Cartridge** from the back of the voting machine until all printing has stopped and you have powered off the voting machine.

4. While the four (4) **Official Election Results Reports** are printing, start closing up the front of the voting machine.
 - a. Carefully remove the curtain by ensuring that both aluminum rods are free from the side panels, roll it up, and place it back into the storage tube (Figure 47).

Figure 47: Storing the Voting Curtain



- b. Make sure the **Full Page Magnifier** and the **Braille Audio Voting Keypad Guide** are replaced in the clear plastic pocket of the **Supply/Lead Voting Machine** left panel. Unlatch the privacy panels (front doors) from the top **white** panel. Fold the top **white** panel down, followed by the right panel, and then the left panel.
5. Lock the door with the **yellow-capped key** (*Figure 48*).

Figure 48: Closing Front Doors of Voting Machine



6. Lower the large voter panel to the down position by pulling the **maroon latch release handle**, which allows the panel to be lowered. **Caution: Do not force panel down.**
7. Make sure there are four (4) **Official Election Results Reports** printed. If you need to print more, use the **“PRINT MORE”** button.
8. All commissioners must sign and date all four (4) **Official Election Results Reports**.
9. Turn the **red “POWER ON-OFF”** knob in the rear of the voting machine to the **“OFF”** position (*Figure 49*).

Figure 49: Turn Power Switch to Off

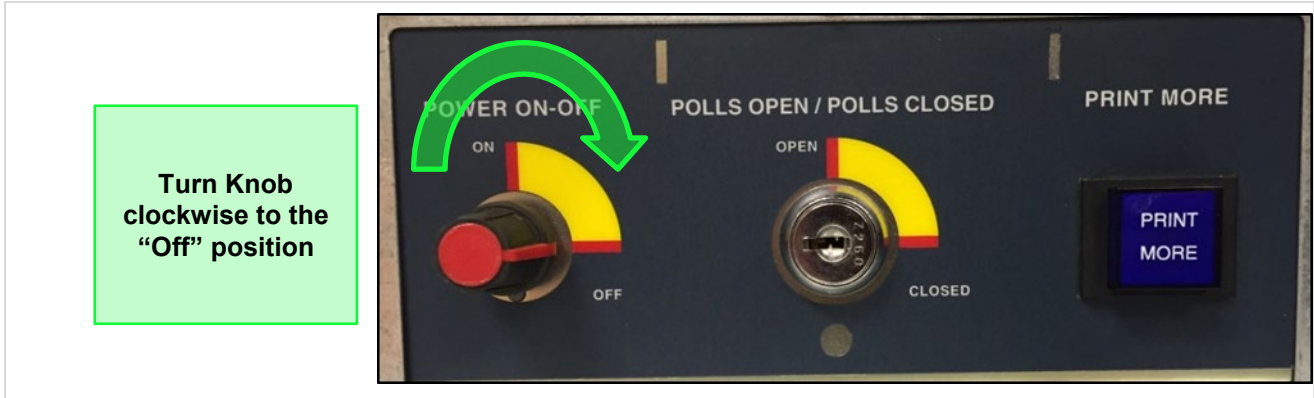

10. Remove the **Blue Results/Audio Cartridge** from the voting machine, **only after the printing has stopped** and the voting machine is powered off, by breaking the protective **red seal** on the clear protective cover over the **Blue Results/Audio Cartridge** and pulling the **Blue Results/Audio Cartridge** straight up (Figures 50 & 51). Place the protective **red seal** and the **Blue Results/Audio Cartridge** in **Clerk's Clear Plastic Zipper Bag**.
11. Remove the operator panel from the side of the voting machine and hang it back into its storage position in the rear of the voting machine.
12. Unplug and place the audio unit and headphones in the storage bag and return to the rear of the voting machine.
13. Unplug the power cord and pull it back gently so that it will retract into the voting machine.

Figure 50: Results/Audio Cartridge Port Location and Removal (Part 1)



Figure 51: Results/Audio Cartridge Port Location and Removal (Part 2)

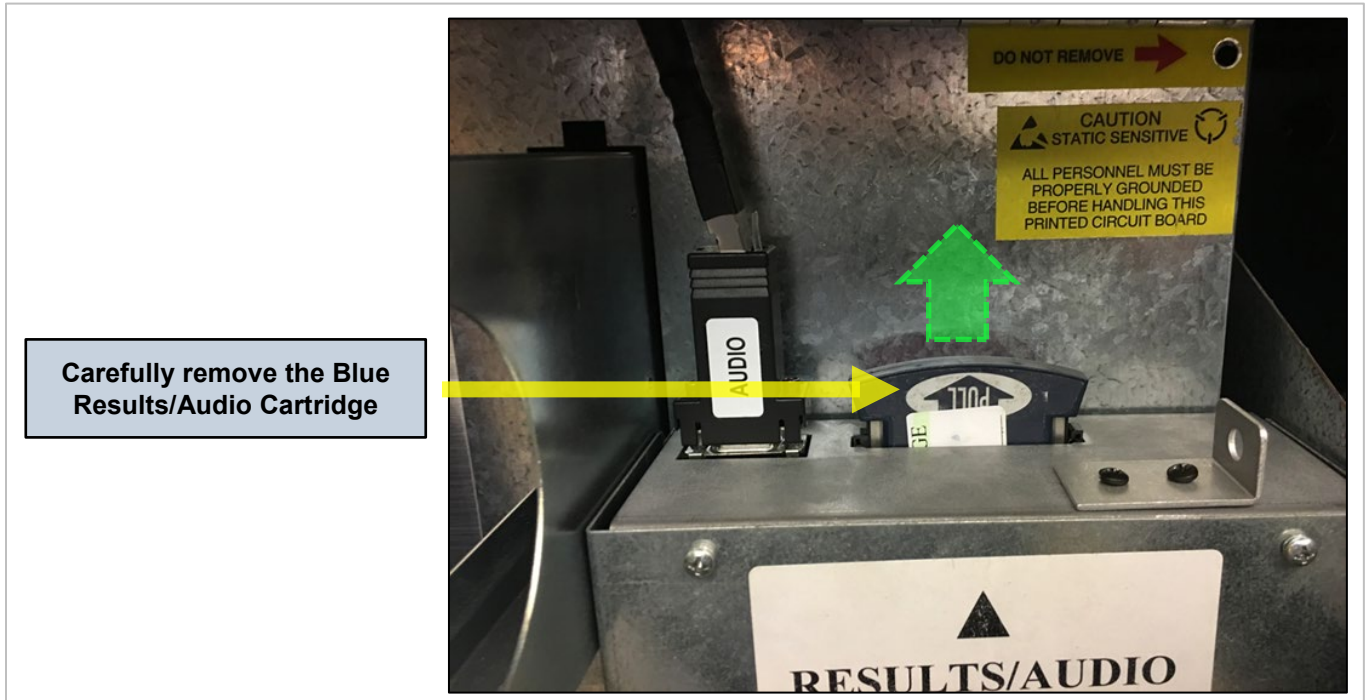

Carefully remove the Blue Results/Audio Cartridge

14. Distribute the four (4) **Official Election Results Reports** (Figure 52) from each voting machine as follows:
 - a. one in the **S-19 Secretary of State Envelope**
 - b. one in the **ROV (Registrar of Voters Envelope)**
 - c. one in the **Clerk's Clear Plastic Zipper Bag** for the clerk of court
 - d. one posted on the outside wall of the polling place location or inside on clear glass so that it may be viewed from the outside of the polling place
15. Finish completing **Certificate No. 2** of the **Machine Certificates (MC-52)** (Figure 53) by filling in the time you closed the polls, the voting machine serial numbers, the public counter numbers (votes cast), the protective counter numbers located on the **Official Election Results Reports**, any visible damage to the machines at close of polls, and the new precinct register seal number(s) used to seal the precinct register(s).
16. Have all commissioners sign the **Machine Certificates (MC-52)** and distribute as follows:
 - a. Original is placed in the **Clerk's Clear Plastic Zipper Bag** for the clerk of court.
 - b. **Pink** copy is placed in the **ROV (Registrar of Voters Envelope)**.
 - c. **Yellow** copy is placed in the **S-19 Secretary of State Envelope**.

Figure 52: Official Election Results Report

OFFICIAL ELECTION RESULTS REPORT

Date 4/5/2016 Time 8:07 pm

Serial Number 1167

Protective Counter 1187

Public Counter 62

Precinct/District
 WARD 1 Precinct 32 B

Polling Place ID 1033202

Ballot Version
 Report Source Internal Machine Memory

**EAST BATON ROUGE PARISH
 GENERAL ELECTION
 APRIL 5, 2016**

Candidate Totals		Total
Candidate	***	***
* LAW ENF DS PROP	C2	(1)
D12	YES	60
D13	NO	2
* P/W MET CNCL PROP 1	C14	(1)
D24	YES	40
D25	NO	22
* P/W MET CNCL PROP 2	E2	(1)
F13	YES	15
F14	NO	47

Write In Votes
 No Write In Votes In Memory

Election Officers

Please Complete After Closing The Polls
 We the undersigned Election Officers do hereby certify that on the 5 day of April 20 16 this board under the scrutiny of each member, closed the polls from further voting obtained this printed record of vote cast on this machine and that after the polls closed, the Protective Counter read 1187 and the Public Counter read 62 and the and the machine has been sealed with seal # _____

Signed:

 Joseph King

 Janet Lee

 Sharon Law

 Louis Black

1. Time

2. Machine Serial #

3. Protective Counter #

4. Public Counter #

5. Fill in the correct date.

6. All commissioners MUST sign and the commissioner-in-charge must post on the outside wall of the polling place location or inside on clear glass.

Figure 53: Machine Certificate (MC-52) No. 2

Machine Certificate No. 2

MACHINE CERTIFICATES - MC-52

INSTRUCTIONS: USE A BALL POINT PEN - PRESS FIRMLY

WE, THE UNDERSIGNED COMMISSIONERS for WARD 01, PRECINCT 01, PARISH OF East Baton Rouge, STATE OF LOUISIANA, hereby certify that we have recorded and verified the following information in accordance with the provisions of the election code.

I. CERTIFICATE NO. 1 - FILLED IN AT THE OPENING OF POLLS

	MACHINE	MACHINE	MACHINE	MACHINE	MACHINE	MACHINE
1. At <u>6:30</u> a.m., voting machine keys were delivered. Key numbers were compared to machine serial numbers. Machine serial numbers were the following:	Serial #	1167	1168	1169	1170	
2. SEAL NUMBERS were compared to cartridge seal number on the Key Envelope A. Cartridge seal numbers were the following:	Seal #	1111	2222	3333	4444	
3. PUBLIC COUNTER NUMBERS (right side of the operator panel) were the following (should be zero):	Public Counter #	0	0	0	0	
4. PROTECTIVE COUNTER NUMBERS (left side of the operator panel) were the following:	Protective Counter #	1125	1000	1100	1200	
5. List any visible damage prior to the start of the election to a voting machine by serial number:	Visible Damage	None	None	None	None	
6. Check the Official Zero Proof Reports to make sure all are zeros (000) and then compare report to sample ballot and AVC ballot on the machine face to confirm they are the same. (Yes or No).....	Report, Sample & AVC Ballot Match? (Yes/No)	Yes	Yes	Yes	Yes	

7. The Precinct Register was delivered with seal number(s): 547651

II. CERTIFICATE NO. 2 - FILLED IN AT THE CLOSING OF POLLS

	MACHINE	MACHINE	MACHINE	MACHINE	MACHINE	MACHINE
1. At <u>8:10</u> p.m., voting machines were closed against further voting. Serial numbers on machines closed were the following:	Serial #	1167	1168	1169	1170	
2. PUBLIC COUNTER NUMBERS (right side of the operator panel) shown were the following:	Public Counter #	62	30	5	5	
3. PROTECTIVE COUNTER NUMBERS (left side of the operator panel) were the following:	Protective Counter #	1187	1030	1105	1205	
4. List any visible damage at the close of the election to a voting machine by serial number that occurred during the election:	Visible Damage	None	None	None	None	

5. The Precinct Register was resealed by the commissioners at the end of the election with seal number(s): 746511

6. After locking machines, place voting machine keys into the C-03 Envelope, sign, and deliver to the clerk of court in the Clear Plastic Zipper Bag.

III. COMMISSIONER CERTIFICATION - SIGNED AFTER COMPLETION OF BOTH CERTIFICATES

IN WITNESS WHEREOF, we have signed our names at 8:25 p.m., on the 5th day of April, 2018

Commissioner-in-Charge Signature: Jon Williams Commissioner's Signature: Jon White
 Commissioner's Signature: Wilma Farrah Commissioner's Signature: Jared Gray
 Commissioner's Signature: Justin Hillman

DISTRIBUTION: Original (white) is delivered to the Clerk of Court in the Clear Plastic Zipper Bag, the yellow is put into the S-19 (Secretary of State Envelope), and the pink is put in the ROV Envelope (Registrar of Voters Envelope).
 Prepared and Furnished by Secretary of State

Machine Certificates (MC-52) Rev. 1/19

17. The commissioner-in-charge fills out the top portion of the **Affidavit of Payroll and Non-Disclosure for Election Day Commissioners (AFF-PND)** (Figure 54) and has every commissioner complete their payroll information.

Note: Commissioner’s payroll is submitted by the clerk of court to the secretary of state within seven (7) days following the election, and checks are issued no later than thirty (30) days thereafter by the secretary of state by mail.

- a. The **Affidavit of Payroll and Non-Disclosure for Election Day Commissioners (AFF-PND)** must be completed by all commissioners. Each commissioner must provide their full name, the last four (4) digits of social security number, mailing address, signature, and initials in order to be paid for working election day. The names should be the same as the name on the social security card. Make sure the last four (4) digits of the social security number are correct.
- b. The hours worked must be completed by each commissioner at the end of the evening and all information must be complete and verified by the commissioner-in-charge. This document is an affidavit; you are swearing that the information on the document is true and correct.
- c. If the **Affidavit of Payroll and Non-Disclosure for Election Day Commissioners (AFF-PND)** is turned into the clerk of court on election night with missing or incorrect information, it may delay the issuance of checks after the election.
- d. Any commissioner address change should be made with the clerk of court prior to election day.
- e. Place in the **Clerk’s Clear Plastic Zipper Bag** for delivery to the clerk of court.

Figure 54: Affidavit of Payroll and Non-Disclosure (AFF-PND)

AFFIDAVIT OF PAYROLL AND NON-DISCLOSURE					
FOR ELECTION DAY COMMISSIONERS					
Use Ballpoint Pen – Press Hard					
<u>East Baton Rouge</u>	Parish	<u>03</u>	Ward	<u>15</u>	Precinct Date <u>7/15/15</u>
<p>Each commissioner shall complete his or her payroll information below and sign. By signing this affidavit, each commissioner swears that the payroll information herein is true and correct to the best of his or her knowledge and acknowledges that he or she is prohibited by law from disclosing any confidential voter information listed in the precinct register.</p>					
NAME (Please Print)	MAILING ADDRESS (Please Print)	SIGNATURE (of Commissioners)	INITIALS	HOURS WORKED (Ex. 5:30am-8:30pm)	
<u>John Doe</u> Commissioner Last four SSN's <u>XXXX</u>	<u>1122 Blue Street</u> <u>Baton Rouge, LA 70808</u>	<u>John Doe</u>	<u>JD</u>	<u>5:30 am</u>	<u>9:00 pm</u>
<u>Jane Doe</u> Commissioner Last four SSN's <u>XXXX</u>	<u>1122 Green Street</u> <u>Baton Rouge, LA 70808</u>	<u>Jane Doe</u>	<u>JD</u>	<u>5:30 am</u>	<u>9:00 pm</u>
<u>Bob Barker</u> Commissioner Last four SSN's <u>XXXX</u>	<u>1122 Yellow Street</u> <u>Baton Rouge, LA 70808</u>	<u>Bob Barker</u>	<u>BB</u>	<u>5:30 am</u>	<u>9:00 pm</u>
<u>Chris Little</u> Commissioner Last four SSN's <u>XXXX</u>	<u>1122 Orange Street</u> <u>Baton Rouge, LA 70808</u>	<u>Chris Little</u>	<u>CL</u>	<u>5:30 am</u>	<u>9:00 pm</u>
Commissioner-in-Charge Last four SSN's _____					<u>9:00 pm</u>
Disposition: Place in the clear plastic zipper bag which is to be delivered to the Clerk of Court. Rev. 6-15			Affidavit of Payroll & Non-Disclosure (AFF-PND) Prepared & Furnished By Secretary of State		

18. Take down the **Official Election Zero Proof Reports** that were posted throughout the day and place it in the **S-19 Secretary of State Envelope**.
19. Take down all the posted signs and discard. Throw away all trash and make sure the polling place is clean and neat.
20. Bring in the A-Frame “VOTE HERE” Disability Sign(s) and place next to the voting machines.

8.04: Completing Required Post-Election Paperwork

- A. Before sealing the following envelopes, check the envelopes and make sure the contents are correct and fill out all information on each envelope, including Parish, Ward, and Precinct.
- B. In the **ROV (Registrar of Voters Envelope)** (*Figure 55*) include
 1. **Address Confirmation Card-Election Day (ACC) Forms**,
 2. **Voter Identification Affidavits (AV-34)**,
 3. the **pink** original copy of the **Challenge of Voter (CV-56) Forms**,
 4. the **pink** copy of the **Machine Certificates (MC-52)**,
 5. the **pink** copy of the **Notation of Irregularities Form**,
 6. the **pink** poll list (**PL-53-Pink**),
 7. **Voter Registration Application (LA-VRA) Forms**,
 8. **Voter Assistance Forms (VAF)**,
 9. **Precinct Register Correction (PRC) Forms**,
 10. one (1) **Official Election Results Report** from each voting machine, and
 11. letters from a medical doctor, optometrist, physician assistant or nurse practitioner certifying the disability certificates and copies of disability documents, if any provided by voters during the day.
- C. Seal the envelope and attach it to the precinct register, or place it in the registrar of voters canvas bag, if one is available. Only completed forms go in the **ROV (Registrar of Voters Envelope)**.

Figure 55: ROV (Registrar of Voters Envelope)

REGISTRAR OF VOTERS ENVELOPE		
Parish	Ward	Precinct
<p>AFTER the election, COMMISSIONERS enclose the following COMPLETED FORMS in this envelope:</p> <ul style="list-style-type: none"> • ACC - ADDRESS CONFIRMATION CARDS - ELECTION DAY, IF ANY • AV-34 - VOTER IDENTIFICATION AFFIDAVIT FORMS, IF ANY • CV-56 - CHALLENGES OF VOTER FORMS (PINK COPY), IF ANY • LA-VRA - VOTER REGISTRATION APPLICATIONS, IF ANY • MC-52 - MACHINE CERTIFICATES (PINK COPY) • NOI - NOTATION OF IRREGULARITIES FORM (PINK COPY) • ONE (1) OFFICIAL ELECTION RESULTS REPORT FROM EACH MACHINE • ONE (1) POLL LIST (PL-53-PINK) • PRC - PRECINCT REGISTER CORRECTION FORMS, IF ANY • VAF - VOTER ASSISTANCE FORM, IF ANY • ANY PHYSICIANS CERTIFICATES OR DISABILITY DOCUMENTATION <p>**ALL UNUSED FORMS ARE TO BE RETURNED IN THE GREEN CANVAS BAG**</p> <p>DISPOSITION: ATTACH TO PRECINCT REGISTER (FOR DELIVERY TO REGISTRAR OF VOTERS)</p> <p><small>Prepared and Furnished by the Secretary of State ROV (Registrar of Voters Envelope) (Rev. 6/19)</small></p>		

D. In the **S-19 Secretary of State Envelope** (Figure 56) include

1. one (1) poll list (**PL-53-Gold**),
2. **yellow** duplicate copy of the **Machine Certificates (MC-52)**,
3. **yellow** copy of the **Notation of Irregularities Form**,
4. one (1) **Official Election Zero Proof Report** from each voting machine, and
5. one (1) **Official Election Results Report** from each voting machine.

E. Fill in the Parish and Ward/Precinct on the **S-19 Secretary of State Envelope**. Seal this envelope and **mail it to secretary of state before midnight (12 a.m.)**.

Figure 56: S-19 Secretary of State Envelope

<table border="1" style="width: 100%; border-collapse: collapse;"> <tr> <td colspan="2" style="text-align: center;">PARISH</td> </tr> <tr> <td colspan="2" style="text-align: center;">East Baton Rouge</td> </tr> <tr> <td style="width: 50%; text-align: center;">WARD</td> <td style="width: 50%; text-align: center;">PRECINCT</td> </tr> <tr> <td style="text-align: center;">1</td> <td style="text-align: center;">1</td> </tr> </table>	PARISH		East Baton Rouge		WARD	PRECINCT	1	1	<p style="text-align: right; font-size: small;">PREPAID NO POSTAGE NECESSARY</p>	
PARISH										
East Baton Rouge										
WARD	PRECINCT									
1	1									
TAMPER - PROOF ENVELOPE - DO NOT OPEN AFTER SEALING										
S-19 (SECRETARY OF STATE ENVELOPE)										
<p>AFTER ELECTION, COMMISSIONERS ENCLOSE IN THIS ENVELOPE THE FOLLOWING:</p> <table style="width: 100%; border: none;"> <tr> <td style="width: 50%; vertical-align: top;"> <ul style="list-style-type: none"> ▪ ONE (1) POLL LIST (PL-53-GOLD) ▪ ONE (1) MACHINE CERTIFICATES (MC-52) (YELLOW COPY) </td> <td style="width: 50%; vertical-align: top;"> <ul style="list-style-type: none"> ▪ ONE (1) OFFICIAL ELECTION ZERO PROOF REPORT FROM EACH MACHINE ▪ NOTATION OF IRREGULARITIES (NOI) FORM (YELLOW COPY) </td> </tr> <tr> <td colspan="2" style="text-align: center;"> <ul style="list-style-type: none"> ▪ ONE (1) OFFICIAL ELECTION RESULTS REPORT FROM EACH MACHINE </td> </tr> </table> <p style="font-size: x-small;">DISPOSITION: AFTER SEALING, COMMISSIONER-IN-CHARGE EXECUTES THE CERTIFICATE ON BACK OF THIS ENVELOPE AND MAILES ON ELECTION NIGHT</p> <p style="font-size: x-small; text-align: center;">SHIP TO: SECRETARY OF STATE P.O. BOX 94125 BATON ROUGE, LA 70804-9125</p>			<ul style="list-style-type: none"> ▪ ONE (1) POLL LIST (PL-53-GOLD) ▪ ONE (1) MACHINE CERTIFICATES (MC-52) (YELLOW COPY) 	<ul style="list-style-type: none"> ▪ ONE (1) OFFICIAL ELECTION ZERO PROOF REPORT FROM EACH MACHINE ▪ NOTATION OF IRREGULARITIES (NOI) FORM (YELLOW COPY) 	<ul style="list-style-type: none"> ▪ ONE (1) OFFICIAL ELECTION RESULTS REPORT FROM EACH MACHINE 					
<ul style="list-style-type: none"> ▪ ONE (1) POLL LIST (PL-53-GOLD) ▪ ONE (1) MACHINE CERTIFICATES (MC-52) (YELLOW COPY) 	<ul style="list-style-type: none"> ▪ ONE (1) OFFICIAL ELECTION ZERO PROOF REPORT FROM EACH MACHINE ▪ NOTATION OF IRREGULARITIES (NOI) FORM (YELLOW COPY) 									
<ul style="list-style-type: none"> ▪ ONE (1) OFFICIAL ELECTION RESULTS REPORT FROM EACH MACHINE 										
TAMPER - PROOF ENVELOPE - DO NOT OPEN AFTER SEALING										
Prepared and Furnished by the Secretary of State	S-19 (Secretary of State Envelope) (Rev. 8/19)									

- F. **DO NOT OPEN an envelope after sealing.** If a form was accidentally left out, write the name of the envelope where it should have been placed in the upper right corner of the form, and deliver it to the Clerk of Court's Office in the **Clerk's Clear Plastic Zipper Bag**.
- G. **SEAL THE PRECINCT REGISTER** with the provided **blue seal**. Place the sealed precinct register and the **ROV (Registrar of Voters Envelope)** in the registrar's bag, if one is available. If not available, just place it in the back of the **Supply/Lead Voting Machine**.
- H. In the **Green Canvas Bag** (*Figure 57*) include
1. the **General Forms Zipper Bag** containing any unused forms;
 2. **Braille Booklet Envelope (BBE)** with Braille Booklet, if a federal election; and
 3. this **Informational Pamphlet for Election Day Voting (IP-Elec. Day)**.
- I. Zip up the bag and place it in the back of the **Supply/Lead Voting Machine**.

Figure 57: Green Canvas Bag



- J. Place the following four (4) items in the back of the **Supply/Lead Voting Machine**:
1. the precinct register, including **Supplemental List Envelope (L-SL)**, (in registrar of voters bag if one is available)
 2. the **ROV (Registrar of Voters Envelope)** (in registrar of voters bag if one is available)
 3. the **Green Canvas Bag**
 4. the **Black Audio Bag** containing audio unit equipment
- K. Lock the rear door of each voting machine and place all **voting machine keys** in the completed and signed **C-03 Key Envelope** (*Figure 58*).

Figure 58: C-03 Key Envelope

VOTING MACHINE RETURN KEY ENVELOPE (AFTER ELECTION)		
PARISH	WARD	PRECINCT
East Baton Rouge	01	26C

AFTER election, Commissioners fill in voting machine number in blanks and sign below.

11667	11668	

We hereby certify the enclosed keys belong to VOTING MACHINES NUMBERED ABOVE:

COMMISSIONER <u>Jon Snow</u>	COMMISSIONER <u>John Doe</u>
COMMISSIONER <u>Jane Doe</u>	COMMISSIONER <u>Jen Snow</u>
COMMISSIONER-IN-CHARGE <u>Laura Noftall</u>	

AFTER election, Commissioner-in-Charge place all keys and ANY B-02 ENVELOPES WHICH WERE OPENED FOR MACHINE REPAIR IN THIS ENVELOPE. Seal envelope in presence of Commissioners, and deliver on election night to your CLERK OF COURT.

C-03 (Rev. 6/15) Issued by SECRETARY OF STATE

- L. Place the following items that go to the Clerk of Court's Office in or with the **Clerk's Clear Plastic Zipper Bag** (Figure 59):
1. original white copy of the **Machine Certificates (MC-52)**
 2. **Affidavit of Payroll and Non-Disclosure for Election Day Commissioners (AFF-PND)**
 3. white original copy of the **Notation of Irregularities Form**
 4. white duplicate copy of the **Challenge of Voter (CV-56) Form**
 5. one (1) **Official Election Results Reports** from each voting machine
 6. the **Blue Results/Audio Cartridges** and the broken protective seals from each voting machine
 7. the completed, signed, and sealed **C-03 Voting Machine Return Key Envelope** (after election)
 8. **Election Day Provisional Packet (ED-PP)** containing all voted paper provisional ballots, pencils, and unused paper provisional ballots and envelopes (if a FEDERAL ELECTION)

Figure 59: Clerk's Clear Plastic Zipper Bag



DO NOT FORGET THE BLUE RESULTS/AUDIO CARTRIDGES!

M. **IMMEDIATELY DELIVER** the **Clerk's Clear Plastic Zipper Bag** to the Clerk of Court's Office on election night.

Part 9: Federal Elections

9.01: What are Federal Elections?

- A. Federal elections are elections mandated by the U.S. Constitution or the state and include the following:
 1. Presidential Preference Primaries (State Mandated)
 2. U.S. President (Constitution)
 3. U.S. Senator (Constitution)
 4. U.S. Representative (Constitution)
- B. Federal elections have more requirements and supplies than non-federal elections.

9.02: Federal Election Supplies

- A. In addition to regular election supplies, federal elections will have additional supplies included that are as follows:
 1. one (1) **Braille Booklet Envelope (BBE)** (*Figure 60*)
 2. one (1) **Election Day Provisional Packet (ED-PP)** (*Figure 61*)
- B. The **Braille Booklet Envelope (BBE)** will be found in the **Green Canvas Bag** in the **Supply/Lead Voting Machine**.
- C. The **Election Day Provisional Packet (ED-PP)** will be in the **Precinct Specific Envelope (PSE)** (*Figure 6*), which will contain the paper provisional ballots for the precinct.

IMPORTANT: ALWAYS OPEN the **Election Day Provisional Packet (ED-PP)** for provisional ballots and supplies for a federal election.
- D. Follow the instructions shown on the face of each envelope, as needed.
- E. If you have a visually impaired voter who needs to use the **Braille Booklet** for voting information, open the **Braille Booklet Envelope (BBE)** to retrieve it.

9.03: Closing the Polling Place during Federal Elections

- A. During federal elections the **Election Day Provisional Packet (ED-PP)** with all voted paper provisional ballots, paper provisional ballot stubs, pencils, and all unused paper provisional ballots and envelopes is placed with the **Clerk's Clear Plastic Zipper Bag** for delivery to the clerk of court on election night.
- B. Commissioners must complete the front of the **Election Day Provisional Packet (ED-PP)**, indicating the total number of provisional voters on the Poll Lists (**PL-53 (Pink)** and **PL-53 (Gold)**) and the total number of voted paper provisional ballots. If the numbers do not match, the commissioner(s) must write an explanation of what happened; if no paper provisional ballots are used, all should be zero.

Figure 60: Braille Booklet Envelope (BBE)

BRAILLE BOOKLET (FEDERAL ELECTIONS) ELECTION DAY – LOUISIANA VOTERS’ BILL OF RIGHTS AND VOTING INFORMATION

INSTRUCTIONS TO COMMISSIONERS:

- 1. OFFER THESE BRAILLE INSTRUCTIONS TO ALL VOTERS WITH A VISUAL IMPAIRMENT.**
- 2. AFTER TERMINATION OF VOTING, RETURN THE BRAILLE BOOKLET TO THIS ENVELOPE AND PUT IN GREEN CANVAS BAG AND RETURN IN THE BACK OF VOTING MACHINE.**

Braille Booklet Envelope (Revised 1/16) (BBE) Issued by Secretary of State

Figure 61: Election Day Provisional Packet

PARISH	WARD	PRECINCT
--------	------	----------

ELECTION DAY PROVISIONAL PACKET

CONTENTS: PROVISIONAL BALLOT(S)
PROVISIONAL BALLOT AFFIDAVIT ENVELOPES (AFF-PB)
PENCILS

INSTRUCTIONS TO COMMISSIONERS:

1. Provisional Voting: You **MUST** open this envelope for your provisional voting supplies in all Federal Elections. Follow the instructions found in the Informational Pamphlet for Election Day Voting (IP ELEC DAY) to allow for Provisional Voting.
2. **YOU MUST COMPLETE THE FOLLOWING BEFORE RETURNING:**
 The total number of provisional voters listed in a poll list, starting at number 1681, is _____; and
 The total number of voted provisional ballots included in this return envelope is _____.
 If numbers do not match, explain: _____.
3. **YOU MUST CHECK THE BOX BELOW IF THE POLLING HOURS WERE EXTENDED ON ELECTION DAY BY A FEDERAL OR STATE COURT ORDER.**
 Extended Poll Hours
4. Return all voted provisional ballots, provisional ballot stubs, unused provisional ballots and envelopes, spoiled provisional ballots and envelopes, and pencils to this envelope.

**DISPOSITION – PUT WITH CLEAR PLASTIC ZIPPER BAG AND DELIVER ON ELECTION NIGHT TO:
CLERK OF COURT**
for delivery to Registrar of Voters **NO LATER THAN 8:30 A.M.** on the first business day after the election.

Prepared and Furnished by Secretary of State Election Day Provisional Packet (ED-PP) (Rev. 04/19)

Part 10: Provisional Voting (Federal Elections Only)

10.01: What is Provisional Voting?

- A. Provisional voting provides a failsafe procedure for voting during federal elections when a person who wants to vote is not listed as an eligible voter, and is not authorized to vote by an election official.
1. The person must certify in writing on the **Provisional Ballot Affidavit Envelope (AFF-PB)** (Figure 62) that they are a registered voter in the parish and are eligible to vote in the election for federal office before voting.
 2. Provisional voting is not a convenience option to allow anyone to vote from any location in the state. It is designed to ensure that every legally eligible vote is counted.
 3. The person must be a registered voter in the parish where they vote and be eligible to vote in the election for federal office for the provisional ballot to be counted. Therefore, it is recommended that the person vote in the precinct and parish where they are registered to vote.
 4. If the person is in the parish where they are registered to vote and they are voting at the wrong precinct, they may vote a paper provisional ballot for federal offices only after certifying in writing on the ballot that they are eligible to vote. **A provisional voter will not be permitted to vote on the voting machines for state, local, or municipal offices; propositions; or state constitutional amendments.** Therefore, it is recommended that the person go to their precinct so that they may vote on all candidates and questions.

Note: All forms and envelopes (except paper provisional ballots) used with provisional voting are printed in **PURPLE INK**.

10.02: When is Provisional Voting Available?

- A. Provisional voting applies only to elections for federal office. It does not apply to local or state elections.

10.03: Who is a Provisional Voter?

- A. Provisional voting applies to four (4) categories of voter:
1. a voter whose name does not appear in the precinct register or supplemental precinct register and who is not authorized to vote by an election official (*Section 7.09: Omissions in Precinct Register and Section 10.06: Precinct Voting - Provisional Voting Chart, Issue (1)(d)*)
 2. a voter who is challenged and a majority of the commissioners determine that the challenge is valid (*Section 7.21: Challenge of Voter at Polls and Section 10.06: Precinct Voting - Provisional Voting Chart, Issue (3)(b)*)
 3. a voter who votes in a federal election during court ordered extended poll hours. (*See 8.02: Extended Poll Hours Voting (Federal Elections)*)
 4. any inactive voter who cannot affirm that they moved outside the parish less than three (3) months before the election and is not eligible to vote in the election (*Section 10.06: Precinct Voting - Provisional Voting Chart, Issue (4)(d)(ii)*)

10.04: Procedure for Determining Provisional Ballot Voter

- A. If a voter's name does not appear in the precinct register or supplemental precinct register, the commissioner must follow the procedures provided in *Section 7.09: Omissions in Precinct Register*.
- B. If the person is authorized to vote as provided in *Section 7.09: Omissions in Precinct Register*, the commissioner will allow the person to complete a **Precinct Register Correction (PRC) Form** and vote on the voting machine. The voter is NOT a provisional voter.
- C. If the person is not authorized to vote as provided in *Section 7.09: Omissions in Precinct Register*, the commissioner shall allow the voter to vote a paper provisional ballot for the federal offices only. **Note:** *The person would be a provisional voter and CANNOT vote on the voting machine.*

Figure 62: Provisional Ballot Affidavit Envelope (AFF-PB)

The diagram shows a Provisional Ballot Affidavit Envelope (AFF-PB) form with two callout boxes on the left. The top callout box, with a green border, points to a red-bordered section of the form and contains the text: "Ballot Number Stub section is removed and given to the voter." The bottom callout box, with a black border, points to two specific fields in the form and contains the text: "Commissioner writes the Ballot Number in these two locations." The form itself is titled "BALLOT ENVELOPE MUST BE SEALED DO NOT DETACH AFFIDAVIT FLAP" and is divided into several sections. At the top, it says "ATTENTION COMMISSIONER: COMPLETE AND DETACH THIS RED PORTION AND GIVE TO VOTER". Below this is a red-bordered box for the "PROVISIONAL BALLOT NUMBER" with the value "867530900". Underneath is a section for the voter: "ATTENTION PROVISIONAL VOTER: You may visit the La. Secretary of State's Voter Portal at https://voterportal.sos.la.gov or call 1-800-883-2805, one week after the election and refer to this provisional ballot number to know if your vote was counted or not, and for the reason if not counted." Below this is a section for the commissioner to complete: "SECTION 1: COMMISSIONER/ELECTION OFFICIAL COMPLETES" with fields for "Provisional Ballot Number" (867530900) and "Select Type(s) of Provisional" (with options for Early Voter, Election Day Voter, Replacement Ballot, and Court Ordered Extended Polling Hours). The next section is "SECTION 2: VOTER COMPLETES, CERTIFIES, AND SIGNS" with instructions to fill in blanks. It includes fields for name (John A. Doe), residence address (1234 West Side Street, Baton Rouge, East Baton Rouge Parish, Louisiana), date of birth (01/01/1900), last 4 digits of SSN (9999), mother's maiden name (Jane), and political party affiliation (No Party). It also has a signature line for the voter (John Doe) and a section for the commissioner to sign ("SECTION 3: COMMISSIONER/ELECTION OFFICIAL SIGNS") with a signature line (Mr. Commissioner) and a printed name line (Mr. Commissioner). At the bottom, there is a field for "Voter Registration # (Office use only-Completed by Registrar of Voters Office)".

10.05: Election Day Provisional Voting Procedures

A. Precinct Register Instructions:

1. The commissioner prints the voter's name in the precinct register on the page for provisional voters behind the **Provisional Voters Tab**.
2. The voter signs next to their name and prints their address in the appropriate fields.
3. The commissioner initials the field next to the signature.
4. Two (2) commissioners write the name of the voter on page 29 of each Poll List (**PL-53 (Pink)** and **PL-53 (Gold)**), starting with number 1681.

B. Provisional Ballot Instructions:

1. The commissioner selects the appropriate provisional ballot from the **Election Day Provisional Packet**, removes the **Ballot Number Stub** (bottom portion of the ballot), and retains the **Ballot Number Stub** to complete the instructions below.

C. **Provisional Ballot Affidavit Envelope (AFF-PB)** (*Figure 62*) Instructions:

1. On the affidavit envelope flap, the commissioner writes the **Ballot Stub Number** in two places, then checks "Election Day Voter" under the "Select Type(s) of Provisional" section and writes the ward (if applicable) and/or precinct number.
2. The voter completes all remaining information on the envelope flap and signs it.
3. The commissioner gives the voter the provisional ballot, the **Provisional Ballot Affidavit Envelope (AFF-PB)**, and a pencil, and directs the voter to a private area where they can mark the ballot in secret.
4. The voter completes the ballot, seals the ballot inside the envelope, and returns it to the commissioner (a pencil is provided so that the voter may change their vote if they choose, but a voter may use a pen to mark the ballot).
5. The commissioner verifies that all information is completed on the sealed envelope flap and that the voter has signed it, and then the commissioner dates and signs it.
6. The commissioner removes the **red "TO THE PROVISIONAL VOTER"** portion of the envelope flap and gives it to the voter, so that the voter may track their ballot through our website application at <https://voterportal.sos.la.gov/ProvisionalVoters> to see if it was counted.
7. The commissioner places the sealed envelope and the ballot number stub inside the **Election Day Provisional Packet (ED-PP)**.

D. Replacement Provisional Ballot Procedures:

1. If the voter spoils their provisional ballot and requests a replacement, the commissioner shall instruct the voter to write "SPOILED" on their provisional ballot(s) and to seal the spoiled ballot(s) in the **Provisional Ballot Affidavit Envelope (AFF-PB)** that was given to them.
2. The commissioner shall write, "SPOILED" across the flap of the **Provisional Ballot Affidavit Envelope (AFF-PB)** and place it in the **Election Day Provisional Packet (ED-PP)**.

3. The commissioner shall check “Replacement Ballot” under the “Select Type(s) of Provisional” section of the affidavit flap and give the voter a replacement provisional ballot and **Provisional Ballot Affidavit Envelope (AFF PB)** to mark.
- E. Place the following items into the **Election Day Provisional Packet (ED-PP)**:
1. all voted paper provisional ballots enclosed in the **Provisional Ballot Affidavit Envelopes (AFF-PB)**
 2. all provisional ballot stubs
 3. any spoiled **Provisional Ballot Affidavit Envelopes (AFF-PB)**
 4. pencils
 5. all unused paper provisional ballots and envelopes
- F. Place **Election Day Provisional Packet (ED-PP)** with the **Clerk’s Clear Plastic Zipper Bag** at the end of voting for delivery to the clerk of court as referenced in *Section 8.04: Completing Required Post-Election Paperwork*.

10.06: Precinct Voting - Provisional Voting Chart

Issue	Commissioner Actions	
1. A person may be authorized to vote when their name does NOT appear in the precinct register or supplemental register .	a. Commissioner MUST call the registrar of voters or the Secretary of State’s Office @800.883.2805 to receive authorization.	
	Commissioner Action	Voter Result
	b. If the registrar of voters or secretary of state authorizes the person to vote, the commissioner completes a Precinct Register Correction (PRC) Form and the voter signs it, the voter signs the precinct register under the Precinct Register Correction Affidavit Tab, and then ----->	<ul style="list-style-type: none"> • Voter is allowed to vote for all eligible offices on the voting machine - VOTER IS NOT A PROVISIONAL VOTER.
	c. If the registrar of voters or secretary of state does NOT authorize the person to vote because they are in the <u>wrong precinct</u> , inform the voter of their correct precinct and that in order to vote on all candidates and questions on the ballot they must vote in their correct precinct. If they want to vote ----->	<ul style="list-style-type: none"> • Voter may cast a <u>paper</u> provisional ballot for federal office(s) only - VOTER IS A PROVISIONAL VOTER. • Voter is NOT allowed to vote on the voting machine.
	d. If the registrar of voters or secretary of state does NOT authorize the person to vote because they are NOT eligible to vote, inform the voter that they have not been authorized to vote. If they want to vote ----->	<ul style="list-style-type: none"> • Voter may cast a <u>paper</u> provisional ballot for federal office(s) - VOTER IS A PROVISIONAL VOTER. • Voter is NOT allowed to vote on the voting machine.
Issue	Commissioner Action	
2. A person’s name was printed incorrectly in the precinct register .	a. The voter completes a Voter Registration Application (LA-VRA) to be sent to the ROV for correction and the voter signs and then----->	
	<ul style="list-style-type: none"> • Voter is allowed to vote for all eligible offices on the voting machine - VOTER IS NOT A PROVISIONAL VOTER. 	

Issue	Commissioner Actions	
3. The voter's name is in the precinct register , but the voter is challenged .	a. The commissioners must vote to determine whether or not the challenge is VALID .	
	Commissioner Action	Voter Result
	b. If challenge is VALID ----->	<ul style="list-style-type: none"> Voter may cast a <u>paper</u> provisional ballot for federal office(s) - VOTER IS A PROVISIONAL VOTER.
c. If challenge is NOT VALID ----->	<ul style="list-style-type: none"> Voter is allowed to vote for all eligible offices on the voting machine - VOTER IS <u>NOT</u> A PROVISIONAL VOTER. 	
Issue	Commissioner Actions	
4. The voter's name is in the precinct register and " ADDRESS CONFIRMATION REQ " is in the signature block.	a. The commissioner follows the instructions on the Address Confirmation Card-Election Day (ACC) Form for completion by both commissioner and voter.	
	Commissioner Action	Voter Result
	b. If a voter checks box one (1), address is correct ----->	<ul style="list-style-type: none"> Voter provides photo identification, or signs a Voter Identification Affidavit (AV-34) if no photo ID, and voter is allowed to vote for all eligible offices on the voting machine - VOTER IS <u>NOT</u> A PROVISIONAL VOTER. Voter may provide a mailing address.
	c. If a voter checks box two (2), address is not correct because voter moved WITHIN the parish-->	<ul style="list-style-type: none"> Voter provides photo identification, or signs a Voter Identification Affidavit (AV-34) if no photo ID, and voter is allowed to vote for all eligible offices on the voting machine - VOTER IS <u>NOT</u> A PROVISIONAL VOTER. Voter MUST provide a new address within the parish and may provide a mailing address in order to vote.
	d. If a voter checks box three (3), address is not correct because voter moved to another address OUTSIDE the parish/state.	<ul style="list-style-type: none"> See Box i and ii.
	i. If it has been less than 3 months since the voter moved----->	<ul style="list-style-type: none"> Voter MUST provide their new address outside the parish in order to vote. Voter provides photo identification, or signs a Voter Identification Affidavit (AV 34) if no photo ID, and voter is allowed to vote for all eligible offices on the voting machine - VOTER IS <u>NOT</u> A PROVISIONAL VOTER.
	ii. If it has been more than 3 months since the voter moved----->	<ul style="list-style-type: none"> Voter is not eligible to vote on the voting machines. Voter shall not complete the Address Confirmation Card-Election Day (ACC) Form, and instead shall complete a voter registration application in order to register to vote for the next election. Voter may cast a paper Provisional Ballot for federal office(s) - VOTER IS A PROVISIONAL VOTER.

Issue	Commissioner Actions	
<p>5. Court Ordered Extended Poll Hours</p>	<p>a. If a commissioner is informed by the clerk of court or secretary of state that poll hours for the election for federal office have been extended by court order, the commissioner shall take the following actions:</p>	
	Commissioner Action	Voter Result
	<p>i. Allow all voters during the extended poll hours to vote a provisional ballot.-----→</p>	<ul style="list-style-type: none"> • Voter may cast a paper provisional ballot for Federal Office(s) - VOTER IS A PROVISIONAL VOTER.
<p>ii. Write "Extended Poll Hours" next to each provisional voter's name in the poll lists (PL-53 (Pink) and PL-53 (Gold)) and check "Extended Poll Hours" under the "Select Type(s) of Provisional" section on each Provisional Ballot Affidavit Envelope (AFF-PB) for each voted ballot.</p>		

Part 11: Criminal Acts

11.01: State Law Prohibitions

- A. voting or attempting to vote more than once in an election
- B. voting at the polls on election day if you have voted early or submitted your absentee ballot
- C. copying or reproducing a voter registration application that has been submitted by an applicant, other than for the purposes of performing official duties relative to registration of voters as provided by law
- D. doing any of the following within 600 feet of the entrance of the polling place on election day:
 - 1. handing out or displaying campaign cards, pictures, or other campaign literature, or placing or displaying political signs, pictures, or other forms of political advertising which advocate for or against any candidate, proposition, or political party appearing on the ballot. The only exception is for placing or displaying political signs or pictures on private property that is not being used as a polling place
 - 2. circulating a petition or seeking handwritten signatures to a petition
- E. knowingly, willfully, or intentionally transmitting or otherwise providing false or misleading information concerning an election from a source disguised as or impersonating the secretary of state, a registrar of voters, a clerk of court, or other election official
- F. appearing at a polling place on election day in an intoxicated condition or possessing any beverage of alcoholic content
- G. carrying or possessing a firearm at a polling place on election day, including if you have a concealed carry permit (the only exception is for a peace officer in the performance of their duties)
- H. voting or attempting to vote while knowing that you are not qualified; or influencing or attempting to influence another to vote while knowing such voter is not qualified or the vote is fraudulent
- I. voting or attempting to vote in someone else's name or under an assumed or fictitious name
- J. supplying a false answer or statement to an election official or on any document required by the Louisiana Election Code; or signing an election affidavit knowing it to contain false or incorrect information
- K. forging someone's name or using a fictitious name on an affidavit or document required by the Louisiana Election Code
- L. signing another voter's name in the precinct register
- M. voting if you have moved more than three (3) months before an election to an address outside of the parish or if registered to vote in another parish or state

- N. bribery of an election official, which is offering money or anything of value or use, directly or indirectly, to any election official with regard to their official duties or engaging in any form of intimidation to influence the actions or inactions of any election official with regard to their official duties
- O. attempting to influence an election official or watcher in the performance of their duties
- P. violating voting machine prohibitions which include unlawfully, directly or indirectly, possessing, tampering with, breaking, impairing, impeding or otherwise interfering with the maintenance, adjustment, delivery, use or operation of any voting machine or with any paraphernalia connected with or appertaining to the machine
- Q. while assisting a voter: (a) allowing a ballot to be seen, except as provided by law, (b) announcing the manner in which a person has cast their ballot, (c) placing a distinguishing mark on a ballot with intent to make the ballot identifiable, or (d) making a false statement concerning a voter's ability to mark a ballot without assistance
- R. while assisting a voter: coercing, compelling, or otherwise influencing the voter to cast their vote in a certain way, or failing to mark the ballot or assist the voter in voting in the manner dictated by the voter
- S. accepting anything of economic value in exchange for transporting a voter to a polling place and/or driving or being in charge of any motor vehicle being used to transport a voter to a polling place (the only exceptions include a bus, taxi, or licensed transportation service)
- T. giving or offering to give money or anything of value to influence a vote or to have a voter sign or not sign a petition
- U. intimidating, deceiving, or misinforming any voter or prospective voter in matters concerning voting or nonvoting
- V. remaining within any polling place or within a radius of 600 feet of the entrance of any polling place, except when exercising the right to vote, after having been directed by a commissioner or law enforcement officer to leave the premises or area of a polling place
- W. disobeying any lawful instruction of the commissioners or a law enforcement officer assisting at the polling place or, without lawful authority, obstructing, hindering or delaying any voter on their way to or while returning home from any polling place where an election is being held, or impeding a voter from entering or exiting a polling place

11.02: Federal Law Prohibitions

- A. intimidating, threatening, or coercing, or attempting to intimidate, threaten, or coerce any person for voting or attempting to vote; or intimidating, threatening, or coercing, or attempting to intimidate, threaten, or coerce any person for urging or aiding any person to vote or attempt to vote; or intimidating, threatening, or coercing any person for exercising any powers or duties under federal law
- B. knowingly and willfully depriving, defrauding, or attempting to deprive or defraud the residents of Louisiana of a fair and impartially conducted election process by the procurement, casting, or tabulation of ballots that are known by the person to be materially false, fictitious, or fraudulent under the laws of the State of Louisiana in any election for federal office
- C. conspiring to injure, oppress, threaten, or intimidate any person in the free exercise or enjoyment of the right to vote or because of their having so exercised the right to vote

Part 12: Law Enforcement

12.01: Law Enforcement Officers

- A. “Law enforcement officer” shall mean any employee of the state, a municipality, a sheriff, or other public agency whose permanent duties include the making of arrests, performing searches and seizures, or the execution of criminal warrants, and who is responsible for the enforcement of the penal, traffic, or highway laws of this state.
- B. A law enforcement officer shall not enter a polling place except to vote or to enforce the orders of the election officials or when there is reasonable belief there is an emergency and commissioners are unable to summon law enforcement officers. The officer shall not interfere with the conduct of the election, the voters, or the election officials.
- C. Law enforcement officers shall not be stationed at polling places on election day.
- D. A commissioner may order any person to leave after they have voted. If the commissioner needs assistance, they may summon law enforcement officers to assist them in the following:
 - 1. preserving order
 - 2. enforcing the election laws
 - 3. protecting election officials from interference in the performance of their duties
- E. Law enforcement officers are not eligible to serve as commissioners-in-charge, commissioners, alternate commissioners, or watchers.
- F. Under Louisiana law, only a law enforcement officer, in the performance of their duties, may carry or possess a firearm at the polling place on election day. Therefore, persons with a concealed carry permit are not allowed to have a firearm in a polling place.

12.02: Elections Compliance Unit

- A. The Elections Compliance Unit, as part of the Louisiana Secretary of State’s Office, is charged with the investigation and reporting of matters involving violations of the Louisiana Election Code. The unit is composed of law enforcement officers with statewide jurisdiction. The unit conducts investigations that involve voter fraud, vote buying, and voter intimidation during early voting, absentee voting, and election day voting.
- B. A member of the Louisiana Secretary of State’s Elections Compliance Unit may enter a polling place on election day or during early voting after receiving a complaint to check the overall operations of the polling place or to investigate any potential violations of the Louisiana Election Code.

Part 13: Commissioners

13.01: Qualifications, Powers and Duties

- A. Qualifications for commissioners-in-charge are to
1. be a qualified voter in the parish and able to perform the essential duties described in this pamphlet;
 2. not be a candidate in the election or a child, child's spouse, brother, brother's spouse, sister, sister's spouse, parent, spouse, or parents of the spouse of a candidate in the precinct where serving;
 3. not have been convicted of an election offense;
 4. have served as commissioner in at least 2 elections in the last 4 years;
 5. not be a law enforcement officer; and
 6. attend training and successfully pass at least 15 questions of a 20 question test.
- B. Qualifications for commissioners and alternate commissioners are to
1. be a qualified voter or a 17-year-old in 12th grade, who is able to perform the essential duties described in this pamphlet;
 2. not be a candidate in the election or a child, child's spouse, brother, brother's spouse, sister, sister's spouse, parent, spouse, or parents of the spouse of a candidate in the precinct where serving;
 3. be registered to vote in the precinct of the ward or precinct of the parish serving, if no wards exist, unless replacements are necessary;
 4. not have been convicted of an election offense;
 5. not be a law enforcement officer; and
 6. attend training and successfully pass at least 10 questions of a 15 question test.
- C. Qualifications for absentee & alternate absentee commissioners are to:
1. be a registered voter in the parish where selected to serve;
 2. be a qualified voter or a 17-year-old in 12th grade, who is able to perform the essential duties described in this pamphlet;
 3. not be a candidate in the election or a child, child's spouse, brother, brother's spouse, sister, sister's spouse, parent, spouse, or parents of the spouse of a candidate in the precinct where serving;
 4. not have been convicted of an election offense;
 5. not be a law enforcement officer; and
 6. attend training and pass at least 10 questions of a 15 question test.

13.02: Powers & Duties, Commissioner-in-Charge

- A. Arrive at the polling place no later than 6:30 a.m. for Saturday elections and 5:30 a.m. for Tuesday elections.
- B. Administer the commissioner's oath of office to all commissioners.
- C. Receive the sealed key envelope from the deputy custodian.
- D. Maintain order at the polling place during the election and opening and closing of the voting machines.
- E. Enforce the laws governing elections at the polling place.
- F. Preside over the election.
- G. Refuse to electioneer, engage in political discussions, unnecessarily delay a voter, or prepare a list of persons voting at the polling place other than the official poll lists.
- H. Deliver keys, election results cartridges, and all other paperwork to clerk of court after polls close.

13.03: Powers & Duties, Commissioners

- A. Arrive at the polling place no later than 6:30 a.m. for Saturday elections and 5:30 a.m. for Tuesday elections.
- B. Take the commissioner's oath of office.
- C. Preside over the election.
- D. Enforce the laws governing elections at the polling place.
- E. Refuse to electioneer, engage in political discussions, unnecessarily delay a voter, or prepare a list of persons voting at the polling place other than the official poll lists.

13.04: Payment

- A. On election night, the **Affidavit of Payroll and Non-Disclosure for Election Day Commissioners (AFF-PND)** (*Figure 54*) must be completed and must be placed in the **Clerk's Clear Plastic Zipper Bag** (*Figure 59*) for delivery to the clerk of court.
 - 1. If the clerk of court does not receive this form on election night, there will be a delay in payment to the commissioners who served in the precinct.
 - 2. Make sure the information for each commissioner is legible and correct so that there will be no discrepancies that would cause a delay in payment.
 - 3. Within seven (7) days, the clerk of court shall transmit the names, addresses, social security numbers, commissioner type, and ward/precinct to the secretary of state.
 - 4. Within thirty (30) days after receiving the commissioner payment information from the clerk of court, the secretary of state mails payment to commissioners.
 - 5. Please allow at least thirty (30) days from the election date to receive your payment before contacting your Clerk of Court's Office for information.

13.05: Disqualification, Commissioner-in-Charge

- A. **Removal:** The parish board of election supervisors may remove any commissioner-in-charge for cause at any time after their selection and before the closing of the polls on election day. Any commissioner removed for cause under the provisions of this section shall not serve as a commissioner in any election for twelve (12) months after their removal.
- B. **Disqualification:** A commissioner-in-charge may be disqualified if they have performed their duties in a negligent manner. Performance of duties in a negligent manner shall include failure to perform any of the duties of commissioner-in-charge or performance of any of the duties of commissioner-in-charge incorrectly.

13.06: Disqualification, Commissioner

- A. **Removal:** The parish board of election supervisors may remove any commissioner for cause at any time after their selection and before the closing of the polls on election day. Any commissioner removed for cause under the provisions of this section shall not serve as a commissioner in any election for twelve (12) months after their removal.
- B. **Disqualification:** (1) A commissioner who fails to appear at the polling place at least thirty (30) minutes before the opening of the polls on election day is disqualified from serving as such in the next primary and general elections held in the ward/precinct where they are registered to vote unless they establish to the satisfaction of the parish board of election supervisors that their absence was for just cause; and (2) A commissioner may be disqualified if they have performed their duties in a negligent manner. Performance of duties in a negligent manner shall include failure to perform any of the duties of commissioner or performance of any of the duties of commissioner incorrectly.

Commissioner Close Polls Checklist

- Secure the voting machines against further voting after the last person in line at 8 p.m. has voted.
- Complete and certify the correctness of the two duplicate poll lists (**PL-53 (Pink)** and **PL-53 (Gold)**) and sign the back covers.
- If there are any discrepancies between the total of all public counters on all voting machines and the two poll lists, make a notation of the reason on the **Notation of Irregularities Form**.
- Remove the voting machine keys from the **B-02 Key Envelope**.
- Unlock and open the back door with the **yellow-capped key**.
- Close the polls by inserting the **silver key** into the “**POLLS OPEN/POLLS CLOSED**” slot and turning the key clockwise to the “**CLOSED**” position. **Caution: Do not turn the key back to “OPEN” position.**
- Once the key is turned to the “**CLOSED**” position, the printer will begin printing four (4) **Official Election Results Reports**. **Do not remove** the **Blue Results/Audio Cartridge** from the back of the voting machine until all printing has stopped!
- While the four (4) **Official Election Results Reports** are printing, start closing up the front of the voting machine.
 - Remove the curtain from the front of the voting machine, roll it up, and place it back into the storage tube.
 - Replace the full page magnifier and the braille audio voting keypad guide in the clear plastic pocket in the voting machine left panel or to the **Green Canvas Bag** (depends on your parish.) Unlatch the privacy panels (front doors) from the top white panel, fold the top white panel down, followed by the right panel, and then the left panel.
 - Secure the latch on the side panels then lock with the **yellow-capped key**.
 - Lower the large voter panel to the down position by pulling the **maroon latch** release handle, which allows the panel to be lowered. **Caution: Do not force panel down.**
- Make sure there are four (4) **Official Election Results Reports** printed. If you need to print more, use the “PRINT MORE” button.
- All commissioners **must** sign and date all four (4) **Official Election Results Reports**.
- Turn the **red “POWER ON-OFF”** knob in the rear of the voting machine to the “**OFF**” position.
- Remove the **Blue Results/Audio Cartridge** from the voting machine by breaking the protective **red seal** on the clear protective cover over the **Blue Results/Audio Cartridge** and pulling straight up. Place the broken protective **red seal** and the **Blue Results/Audio Cartridge** in the **Clerk’s Clear Plastic Zipper Bag**.
- Remove the operator panel from the side of the voting machine and hang it back into its storage position in the rear of the voting machine.
- Remove the audio unit and headphones and place in the storage bag in the rear of the **lead/supply voting machine**.
- Unplug the power cord and pull it back gently so that it will retract back into the voting machine.

- Distribute the four (4) **Official Election Results Reports** from each voting machine as follows:
 - one in the **S-19 Secretary of State Envelope**
 - one in the **ROV (Registrar of Voters Envelope)**
 - one in the **Clerk's Clear Plastic Zipper Bag** for the clerk of court
 - one posted on the outside wall of the polling place location or inside on clear glass so that it may be viewed from the outside of the polling place
 - Seal the **precinct register** with the **blue seal**, attach the **ROV (Registrar of Voters Envelope)** to the precinct register, and place it in the registrar of voters bag if one is available. If not available, just place it in the back of the **Supply/Lead Voting Machine**.
 - Finish filling out Certificate No. 2 of the **Machine Certificates (MC-52)** using the **Official Election Results Reports**.
 - Take down the **Official Election Zero Proof Reports** that were posted throughout the day and place them in the **S-19 Secretary of State Envelope**.
 - Place all unused forms and extra supplies (except provisional voting materials) that can be reused in the **General Forms Zipper Bag** and place it in the **Green Canvas Bag**.
 - Place the **Green Canvas Bag** in the back of the voting machine.
 - Take down and throw away all posted signs. Throw away the **Precinct Specific Envelope (PSE)** and all trash. **Make sure the polling place is clean and neat**.
 - Bring in the A-Frame "VOTE HERE" Disability Sign(s) and place next to the voting machines.
 - Before sealing any envelopes, check the envelopes and make sure the contents are correct, and fill out all information on each envelope.
 - After confirming that the correct forms are in each envelope, sign and seal the **S-19 Secretary of State Envelope**.
- BE SURE TO FILL IN THE PARISH AND WARD/PRECINCT ON EACH ENVELOPE. ONCE THE TAMPER-PROOF ENVELOPE IS SEALED, DO NOT OPEN IT.** (If a form was accidentally left out, then in the upper right corner of the form, write the name of the envelope where it should have been placed, and deliver it to the Clerk of Court's Office.)
- Only four (4) things go in the back of the **Supply/Lead Voting Machine**:
 - the **precinct register, including Supplemental List Envelope (L-SL)** (in registrar of voters bag, if one is available)
 - the **ROV (Registrar of Voters Envelope)** (in registrar of voters bag, if one is available)
 - the **Green Canvas Bag**
 - the **Black Audio Bag** containing audio unit equipment
 - Close and lock the back door using the **yellow-capped key**.
 - Complete the **C-03 Key Envelope** and have all commissioners sign the envelope and seal it.

- Place the following into or with **Clerk's Clear Plastic Zipper Bag**:
 - original white copy of the **Machine Certificates (MC-52)**
 - Affidavit of Payroll and Non-Disclosure for Election Day Commissioners (AFF-PND)**
 - original white copy of the **Notation of Irregularities Form**
 - white duplicate copy of the **Challenge of Voter (CV-56) Form**
 - one (1) **Official Election Results Reports** from each voting machine
 - the **Blue Results/Audio Cartridges** and the broken protective **red seals** from each voting machine
 - the completed and signed **C-03 Voting Machine Return Key Envelope** (After Election)
 - Election Day Provisional Packet (ED-PP)** containing all voted paper provisional ballots, pencils, and unused paper provisional ballots and envelopes if a FEDERAL ELECTION
- IMPORTANT:** All provisional materials **MUST** be delivered to the Clerk of Court's Office on election night in the **Clerk's Clear Plastic Zipper Bag**.
- Deliver the **Clerk's Clear Plastic Zipper Bag** to the clerk of court.
- Mail the **S-19 Secretary of State Envelope** to the secretary of state before midnight (12 a.m.). **BE SURE TO FILL IN THE PARISH AND WARD/PRECINCT ON THE ENVELOPE!**

This public document was published at a total cost of \$. # copies of this public document were published in this first printing at a cost of \$. This document was published by the Office of State Printing, 1201 North 3rd Street, Baton Rouge, LA 70802, to provide a guide for commissioners-in-charge and commissioners on Election Day and to provide information to prospective commissioners for their use in taking the test required by R.S. 18:421. This material was printed in accordance with standards for printing by state agencies established pursuant to R.S. 43:31. Printing of this material was purchased in accordance with the provisions of Title 43 of the Louisiana Revised Statutes.

OATH

I, _____ do solemnly swear (or affirm) that I will support the Constitution and Laws of the United States and the Constitution and Laws of this state and that I will faithfully and impartially discharge and perform all the duties incumbent upon me as commissioner (-in-charge) according to the best of my ability and understanding, so help me God.

ACKNOWLEDGEMENT

I, _____ acknowledge that state law prohibits the disclosure of confidential voter information listed in the precinct register, which includes a voter's day and month of birth, mother's maiden name, and if the voter is entitled to assistance in voting.

IMPORTANT CONTACT INFORMATION

Louisiana Secretary of State's Office - 225.922.0900 or toll-free at 1.800.883.2805
Election Fraud and Compliance Unit - 1.800.722.5305

Louisiana Secretary of State's website - <http://www.sos.la.gov>



VOTER INFORMATION SEARCH

Louisiana Secretary of State's GeauxVote mobile site -
<https://voterportal.sos.la.gov/MobileLanding.aspx>

